



---

# AIRPLANE FLIGHT MANUAL

## DA 40 D

---

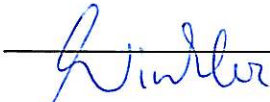
**Airworthiness Category** : Normal, Utility  
**Requirement** : JAR-23  
**Serial Number** : \_\_\_\_\_  
**Registration** : \_\_\_\_\_  
**Doc. No.** : 6.01.05-E  
**Date of Issue** : 11 November 2002

Signature :  \_\_\_\_\_  
Authority : \_\_\_\_\_  
Stamp :  \_\_\_\_\_  
Date of approval : \_\_\_\_\_  
  
09. DEZ. 2004

- | This Flight Manual has been verified for EASA by the Austrian Civil Aviation Authority
- | Austro Control (ACG) as Primary Certification Authority (PCA) in accordance with the
- | valid Certification Procedures and approved by EASA with approval no. 2004-12326
- | This Flight Manual has been approved by EASA on behalf of CAAC-AAD.

Intentionally left blank.

**FOREWORD**

We congratulate you on the acquisition of your new DIAMOND DA 40 D.

Skillful operation of an airplane increases both safety and the enjoyment of flying. Please take the time therefore, to familiarize yourself with your new DIAMOND DA 40 D.

This airplane may only be operated in accordance with the procedures and operating limitations of this Airplane Flight Manual.

Before this airplane is operated for the first time, the pilot must familiarize himself with the complete contents of this Airplane Flight Manual.

In the event that you have obtained your DIAMOND DA 40 D second-hand, please let us know your address, so that we can supply you with the publications necessary for the safe operation of your airplane.

This document is protected by copyright. All associated rights, in particular those of translation, reprinting, radio transmission, reproduction by photo-mechanical or similar means and storing in data processing facilities, in whole or part, are reserved.

Copyright © by: DIAMOND AIRCRAFT INDUSTRIES GMBH  
N.A. Otto-Strasse 5  
A-2700 Wiener Neustadt, Austria  
Phone. : +43-2622-26700  
Fax : +43-2622-26780  
E-Mail : [office@diamond-air.at](mailto:office@diamond-air.at)

## **0.1 APPROVAL**

The content of approved chapters is approved by EASA. All other content is approved by DAI under the authority of EASA DOA No. EASA.21J.052 in accordance with Part 21.

## **0.2 RECORD OF REVISIONS**

All revisions of this manual, with the exception of -

- Temporary Revisions,
- updates of the modification level (Section 1.1),
- updated mass and balance information (Section 6.3),
- updates of the Equipment Inventory (Section 6.5), and
- updates of the List of Supplements (Section 9.2)

must be recorded in the following table.

The new or amended text is indicated by a vertical black line at the left hand side of the revised page, with the revision number and date appearing at the bottom of the page.

If pages are revised which contain information valid for your particular serial number (modification level of the airplane, weighing data, Equipment Inventory, List of Supplements), then this information must be transferred to the new pages in hand-writing.

Temporary Revisions, if applicable, are inserted behind the cover page of this manual. Temporary Revisions are used to provide information on systems or equipment until the next 'permanent' Revision of the Airplane Flight Manual. When a 'permanent' Revision covers a Mandatory or Optional Design Change Advisory (MÄM or OÄM), then the corresponding Temporary Revision is superseded. For example: Revision 5 covers OÄM 40-039, therefore the Temporary Revision TR OÄM-40-039 is superseded by the 'permanent' Revision 5.

Rev. No.	Reason	Chapter	Page(s)	Date of Revision	Approval	Date of Approval	Date Inserted	Signature
1	OÄM 40-105 OÄM 40-106	all	all	03-Mar-2003	[approved by Ing. Andreas Winkler for ACG]	07-Mar-2003		
2	OÄM 40-096 OÄM 40-130	0, 1, 2, 4a, 5, 6, 7	0-3,4,5,6,7,8 1-2 2-1, 2-11, 2-19, 20, 21, 22, 23, 24, 25, 26 4A-3 5-24 6-1, 6-5, 6-8, 6-9, 10, 11, 12, 13, 14, 15, 16, 17, 18 7-1, 7-26, 7-27, 7-28, 29, 30, 31, 32, 33, 34, 35, 36, 37, 38, 39, 40, 41, 42, 43, 44	30-Apr-2003	[approved by Ing. Andreas Winkler for ACG]	08-May-2003		
3	OÄM 40-099 OÄM 40-118 OÄM 40-132 OÄM 40-136 OÄM 40-137 OÄM 40-142 OÄM 40-143 OÄM 40-144 OÄM 40-145 OÄM 40-148 OÄM 40-149	0,1,2,3, 4a,4b,5, 6,7,9	0-3 thru 0-8, 1-13, 1-14, 2-1, 2-6, 2-8, 2-16 thru 2-28, 3-2, 3-22 3-29, 3-31, 4a-1, 4a-14 thru 4a-23, 4b-5, 4b-12, 5-1, 5-6 thru 5-25, 6- 3, 6-15 thru 6-20, 7- 1, 7-9 thru 7-51, 9-1, 9-3 thru 9-6	26-May-2003	[approved by Ing. Andreas Winkler for ACG]	18-Jun-2003		

Rev. No.	Reason	Chapter	Page(s)	Date of Revision	EASA Approval No.	ACG Compliance	Date Inserted	Signature
4	type certification in China	0	0-0, 0-4 thru 0-10	15 Sep 2004	2004-12326	[approved by Ing. Andreas Winkler for ACG]		
5	<p><b>MÄM 40-</b> -101, -122, -123/e, -124, -133, -137, -144, -147, -151, -155, -169, -174, -176, -207, -210, -246/a, -253, -256/b, -336, -343,</p> <p><b>OÄM 40-</b> -100/c, -124, -132/a, -136/a, -137/b, -142/a, -144/a, -144/b, -151, -151/a, -153, -153/a, -153/b, -157, -157/a, -158, -158/a, -159, -159/a, -165, -166, -169 thru -177, -180, -182, -183, -184/a, -185, -191, -193, -199,</p>	all	all, except cover page	01 Jun 2008		<p>18. JULI 2008</p>  <p>For DAI:</p>		

Rev. No.	Reason	Chapter	Page(s)	Date of Revision	EASA Approval No.	ACG Compliance	Date Inserted	Signature
5	OÄM 40- -200, -204, -208, -214, -217, -224/a, -227/a, -234, -237, -239, -244, -245, -247, -250/a, -267, -268, -271, -275, -277, -278, -293, -294, -297,  corrections	all	all, except cover page	01 Jun 2008		 18. JULI 2008 For DAf:		

### 0.3 LIST OF EFFECTIVE PAGES

Ch.	Page	Date
0	0-0	15-Sep-2004
	0-0a	01-Jun-2008
	0-1	01-Jun-2008
	0-2	01-Jun-2008
	0-3	01-Jun-2008
	0-4	01-Jun-2008
	0-5	01-Jun-2008
	0-6	01-Jun-2008
	0-7	01-Jun-2008
	0-8	01-Jun-2008
	0-9	01-Jun-2008
	0-10	01-Jun-2008
	0-11	01-Jun-2008
	0-12	01-Jun-2008
	0-13	01-Jun-2008
	0-14	01-Jun-2008

Ch.	Page	Date
1	1-1	01-Jun-2008
	1-2	01-Jun-2008
	1-3	01-Jun-2008
	1-4	01-Jun-2008
	1-5	01-Jun-2008
	1-6	01-Jun-2008
	1-7	01-Jun-2008
	1-8	01-Jun-2008
	1-9	01-Jun-2008
	1-10	01-Jun-2008
	1-11	01-Jun-2008
	1-12	01-Jun-2008
	1-13	01-Jun-2008
	1-14	01-Jun-2008
	1-15	01-Jun-2008
	1-16	01-Jun-2008
	1-17	01-Jun-2008
	1-18	01-Jun-2008
	1-19	01-Jun-2008
	1-20	01-Jun-2008
	1-21	01-Jun-2008
	1-22	01-Jun-2008



Ch.	Page	Date
2	2-1	01-Jun-2008
	appr. 2-2	01-Jun-2008
	appr. 2-3	01-Jun-2008
	appr. 2-4	01-Jun-2008
	appr. 2-5	01-Jun-2008
	appr. 2-6	01-Jun-2008
	appr. 2-7	01-Jun-2008
	appr. 2-8	01-Jun-2008
	appr. 2-9	01-Jun-2008
	appr. 2-10	01-Jun-2008
	appr. 2-11	01-Jun-2008
	appr. 2-12	01-Jun-2008
	appr. 2-13	01-Jun-2008
	appr. 2-14	01-Jun-2008
	appr. 2-15	01-Jun-2008
	appr. 2-16	01-Jun-2008
	appr. 2-17	01-Jun-2008
	appr. 2-18	01-Jun-2008
	appr. 2-19	01-Jun-2008
	appr. 2-20	01-Jun-2008
	appr. 2-21	01-Jun-2008
	appr. 2-22	01-Jun-2008
	appr. 2-23	01-Jun-2008
	appr. 2-24	01-Jun-2008
	appr. 2-25	01-Jun-2008
	appr. 2-26	01-Jun-2008
	appr. 2-27	01-Jun-2008
	appr. 2-28	01-Jun-2008
	appr. 2-29	01-Jun-2008

Ch.	Page	Date
2	appr. 2-30	01-Jun-2008
	appr. 2-31	01-Jun-2008
	appr. 2-32	01-Jun-2008

Ch.	Page	Date
3	3-1	01-Jun-2008
	3-2	01-Jun-2008
	3-3	01-Jun-2008
	3-4	01-Jun-2008
	3-5	01-Jun-2008
	3-6	01-Jun-2008
	3-7	01-Jun-2008
	3-8	01-Jun-2008
	3-9	01-Jun-2008
	3-10	01-Jun-2008
	3-11	01-Jun-2008
	3-12	01-Jun-2008
	3-13	01-Jun-2008
	3-14	01-Jun-2008
	3-15	01-Jun-2008
	3-16	01-Jun-2008
	3-17	01-Jun-2008
	3-18	01-Jun-2008
	3-19	01-Jun-2008
	3-20	01-Jun-2008
	3-21	01-Jun-2008
	3-22	01-Jun-2008
	3-23	01-Jun-2008
	3-24	01-Jun-2008
	3-25	01-Jun-2008
	3-26	01-Jun-2008
	3-27	01-Jun-2008
	3-28	01-Jun-2008
	3-29	01-Jun-2008

Ch.	Page	Date
3	3-30	01-Jun-2008
	3-31	01-Jun-2008
	3-32	01-Jun-2008
	3-33	01-Jun-2008
	3-34	01-Jun-2008

Ch.	Page	Date
4A	4A-1	01-Jun-2008
	4A-2	01-Jun-2008
	4A-3	01-Jun-2008
	4A-4	01-Jun-2008
	4A-5	01-Jun-2008
	4A-6	01-Jun-2008
	4A-7	01-Jun-2008
	4A-8	01-Jun-2008
	4A-9	01-Jun-2008
	4A-10	01-Jun-2008
	4A-11	01-Jun-2008
	4A-12	01-Jun-2008
	4A-13	01-Jun-2008
	4A-14	01-Jun-2008
	4A-15	01-Jun-2008
	4A-16	01-Jun-2008
	4A-17	01-Jun-2008
	4A-18	01-Jun-2008
	4A-19	01-Jun-2008
	4A-20	01-Jun-2008
	4A-21	01-Jun-2008
	4A-22	01-Jun-2008
	4A-23	01-Jun-2008
	4A-24	01-Jun-2008
	4A-25	01-Jun-2008
	4A-26	01-Jun-2008
	4A-27	01-Jun-2008
	4A-28	01-Jun-2008
	4A-29	01-Jun-2008

Ch.	Page	Date
4A	4A-30	01-Jun-2008
4B	4B-1	01-Jun-2008
	4B-2	01-Jun-2008
	4B-3	01-Jun-2008
	4B-4	01-Jun-2008
	4B-5	01-Jun-2008
	4B-6	01-Jun-2008
	4B-7	01-Jun-2008
	4B-8	01-Jun-2008
	4B-9	01-Jun-2008
	4B-10	01-Jun-2008
	4B-11	01-Jun-2008
	4B-12	01-Jun-2008
	4B-13	01-Jun-2008
	4B-14	01-Jun-2008
	4B-15	01-Jun-2008
	4B-16	01-Jun-2008
	4B-17	01-Jun-2008
	4B-18	01-Jun-2008
	4B-19	01-Jun-2008
	4B-20	01-Jun-2008
	4B-21	01-Jun-2008
	4B-22	01-Jun-2008

Ch.	Page	Date
5	5-1	01-Jun-2008
	5-2	01-Jun-2008
	5-3	01-Jun-2008
	5-4	01-Jun-2008
	5-5	01-Jun-2008
	5-6	01-Jun-2008
	5-7	01-Jun-2008
	5-8	01-Jun-2008
	5-9	01-Jun-2008
	5-10	01-Jun-2008
	5-11	01-Jun-2008
	5-12	01-Jun-2008
	5-13	01-Jun-2008
	5-14	01-Jun-2008
	5-15	01-Jun-2008
	5-16	01-Jun-2008
	5-17	01-Jun-2008
	5-18	01-Jun-2008
	5-19	01-Jun-2008
	5-20	01-Jun-2008
	5-21	01-Jun-2008
	5-22	01-Jun-2008
	5-23	01-Jun-2008
	5-24	01-Jun-2008
	5-25	01-Jun-2008
	5-26	01-Jun-2008
	5-27	01-Jun-2008
	5-28	01-Jun-2008

Ch.	Page	Date
6	6-1	01-Jun-2008
	6-2	01-Jun-2008
	6-3	01-Jun-2008
	6-4	01-Jun-2008
	6-5	01-Jun-2008
	6-6	01-Jun-2008
	6-7	01-Jun-2008
	6-8	01-Jun-2008
	6-9	01-Jun-2008
	6-10	01-Jun-2008
	6-11	01-Jun-2008
	6-12	01-Jun-2008
	6-13	01-Jun-2008
	6-14	01-Jun-2008
	6-15	01-Jun-2008
	6-16	01-Jun-2008
	6-17	01-Jun-2008
	6-18	01-Jun-2008
	6-19	01-Jun-2008
	6-20	01-Jun-2008
	6-21	01-Jun-2008
	6-22	01-Jun-2008

Ch.	Page	Date
7	7-1	01-Jun-2008
	7-2	01-Jun-2008
	7-3	01-Jun-2008
	7-4	01-Jun-2008
	7-5	01-Jun-2008
	7-6	01-Jun-2008
	7-7	01-Jun-2008
	7-8	01-Jun-2008
	7-9	01-Jun-2008
	7-10	01-Jun-2008
	7-11	01-Jun-2008
	7-12	01-Jun-2008
	7-13	01-Jun-2008
	7-14	01-Jun-2008
	7-15	01-Jun-2008
	7-16	01-Jun-2008
	7-17	01-Jun-2008
	7-18	01-Jun-2008
	7-19	01-Jun-2008
	7-20	01-Jun-2008
	7-21	01-Jun-2008
	7-22	01-Jun-2008
	7-23	01-Jun-2008
	7-24	01-Jun-2008
	7-25	01-Jun-2008
	7-26	01-Jun-2008
	7-27	01-Jun-2008
	7-28	01-Jun-2008
	7-29	01-Jun-2008

Ch.	Page	Date
7	7-30	01-Jun-2008
	7-31	01-Jun-2008
	7-32	01-Jun-2008
	7-33	01-Jun-2008
	7-34	01-Jun-2008
	7-35	01-Jun-2008
	7-36	01-Jun-2008
	7-37	01-Jun-2008
	7-38	01-Jun-2008
	7-39	01-Jun-2008
	7-40	01-Jun-2008
	7-41	01-Jun-2008
	7-42	01-Jun-2008
	7-43	01-Jun-2008
	7-44	01-Jun-2008
	7-45	01-Jun-2008
	7-46	01-Jun-2008
	7-47	01-Jun-2008
	7-48	01-Jun-2008
	7-49	01-Jun-2008
	7-50	01-Jun-2008

Ch.	Page	Date
8	8-1	01-Jun-2008
	8-2	01-Jun-2008
	8-3	01-Jun-2008
	8-4	01-Jun-2008
	8-5	01-Jun-2008
	8-6	01-Jun-2008
	8-7	01-Jun-2008
	8-8	01-Jun-2008
	8-9	01-Jun-2008
	8-10	01-Jun-2008
	8-11	01-Jun-2008
	8-12	01-Jun-2008

Ch.	Page	Date
9	9-1	01-Jun-2008
	9-2	01-Jun-2008
	9-3	01-Jun-2008
	9-4	01-Jun-2008
	9-5	01-Jun-2008
	9-6	01-Jun-2008

## **0.4 TABLE OF CONTENTS**

	Chapter
<b>GENERAL</b>	
(a non-approved chapter) .....	1
<b>OPERATING LIMITATIONS</b>	
(an approved chapter) .....	2
<b>EMERGENCY PROCEDURES</b>	
(a non-approved chapter) .....	3
<b>NORMAL OPERATING PROCEDURES</b>	
(a non-approved chapter) .....	4A
<b>ABNORMAL OPERATING PROCEDURES</b>	
(a non-approved chapter) .....	4B
<b>PERFORMANCE</b>	
(a non-approved chapter) .....	5
<b>MASS AND BALANCE / EQUIPMENT LIST</b>	
(a non-approved chapter) .....	6
<b>DESCRIPTION OF THE AIRPLANE AND ITS SYSTEMS</b>	
(a non-approved chapter) .....	7
<b>AIRPLANE HANDLING, CARE AND MAINTENANCE</b>	
(a non-approved chapter) .....	8
<b>SUPPLEMENTS</b> .....	9

Intentionally left blank.



# CHAPTER 1

## GENERAL

	Page
1.1 INTRODUCTION .....	1-2
1.2 CERTIFICATION BASIS .....	1-4
1.3 WARNINGS, CAUTIONS AND NOTES .....	1-5
1.4 DIMENSIONS .....	1-6
1.5 DEFINITIONS AND ABBREVIATIONS .....	1-8
1.6 UNITS OF MEASUREMENT .....	1-17
1.6.1 CONVERSION FACTORS .....	1-17
1.6.2 CONVERSION CHART LITERS / US GALLONS .....	1-19
1.7 THREE-VIEW DRAWING .....	1-20
1.8 SOURCE DOCUMENTATION .....	1-21
1.8.1 ENGINE AND ENGINE INSTRUMENTS .....	1-21
1.8.2 PROPELLER .....	1-22

## 1.1 INTRODUCTION

This Airplane Flight Manual has been prepared in order to provide pilots and instructors with all the information required for the safe and efficient operation of the airplane.

The Airplane Flight Manual includes all the data which must be made available to the pilot according to the JAR-23 requirement. Beyond this, it contains further data and operating instructions which, in the manufacturer's opinion, could be of value to the pilot.

This Airplane Flight Manual is valid for all serial numbers. Equipment and modification level (design details) of the airplane may vary from serial number to serial number. Therefore, some of the information contained in this manual is applicable depending on the respective equipment and modification level. The exact equipment of your serial number is recorded in the Equipment Inventory in Section 6.5. The modification level is recorded in the following table (as far as necessary for this manual).

### **NOTE**

If the Garmin G1000 System is installed, the warning, caution and advisory alerts differ from those contained in the AFM. Refer to Supplement A32, Integrated Avionics System, G1000, Garmin, IFR-Operation (OÄM 40-193 and OÄM 40-278) or Supplement A31, Integrated Avionics System, G1000, Garmin, VFR-Operation (OÄM 40-224 and OÄM 40-268) for further information.

Modification	Source	Installed	
Increase of Fuel Temp Limit	MÄM 40-106	<input type="checkbox"/> yes	<input type="checkbox"/> no
Use of Diesel Fuel	MÄM 40-129		
Modified MLG-Strut	MÄM 40-123	<input type="checkbox"/> yes	<input type="checkbox"/> no
TAE 125 Rev. 5 Engine	MÄM 40-124	<input type="checkbox"/> yes	<input type="checkbox"/> no
Coolant G30	MÄM 40-147	<input type="checkbox"/> yes	<input type="checkbox"/> no
Alternator with External Regulator	MÄM 40-151	<input type="checkbox"/> yes	<input type="checkbox"/> no
Fuel Cooler	MÄM 40-169	<input type="checkbox"/> yes	<input type="checkbox"/> no
Use of Jet A and Jet Fuel No. 3	MÄM 40-246	<input type="checkbox"/> yes	<input type="checkbox"/> no
TAE 125-02-99 Engine	MÄM 40-256	<input type="checkbox"/> yes	<input type="checkbox"/> no
AED/CED in combination with TAE 125-02-99 Engine	OÄM 40-293	<input type="checkbox"/> yes	<input type="checkbox"/> no
Muffler	OÄM 40-096	<input type="checkbox"/> yes	<input type="checkbox"/> no
Long Range Tank	OÄM 40-130	<input type="checkbox"/> yes	<input type="checkbox"/> no
Winter Baffle Fresh Air Inlet	OÄM 40-183	<input type="checkbox"/> yes	<input type="checkbox"/> no
Nose Landing Gear Tie-down	OÄM 40-200	<input type="checkbox"/> yes	<input type="checkbox"/> no
ELT Artex ME 406	OÄM 40-247	<input type="checkbox"/> yes	<input type="checkbox"/> no
Autopilot Static Source	OÄM 40-267	<input type="checkbox"/> yes	<input type="checkbox"/> no
Garmin G1000, VFR	OÄM 40-224	<input type="checkbox"/> yes	<input type="checkbox"/> no
Garmin G1000, VFR without A/P	OÄM 40-268	<input type="checkbox"/> yes	<input type="checkbox"/> no
Garmin G1000, IFR	OÄM 40-193	<input type="checkbox"/> yes	<input type="checkbox"/> no
Garmin G1000, IFR without A/P	OÄM 40-278	<input type="checkbox"/> yes	<input type="checkbox"/> no

This Airplane Flight Manual must be kept on board the airplane at all times. Its designated place is the side bag of the forward left seat.

### **CAUTION**

The DA 40 D is a single engine airplane. When the operating limitations and maintenance requirements are complied with, it has the high degree of reliability which is required by the certification basis. Nevertheless, an engine failure is not completely impossible. For this reason, flights during the night, on top, under instrument meteorological conditions (IMC), or above terrain which is unsuitable for a landing, constitute a risk. It is therefore highly recommended to select flight times and flight routes such that this risk is minimized.

## **1.2 CERTIFICATION BASIS**

This airplane has been type certified in accordance with the JAA JC/VP procedure. The certification basis is JAR-23, published on 11-Mar-1994, including Amdt.1, and additional requirements as laid down in CRI A-01.

### 1.3 WARNINGS, CAUTIONS AND NOTES

Special statements in the Airplane Flight Manual concerning the safety or operation of the airplane are highlighted by being prefixed by one of the following terms:

#### **WARNING**

means that the non-observation of the corresponding procedure leads to an immediate or important degradation in flight safety.

#### **CAUTION**

means that the non-observation of the corresponding procedure leads to a minor or to a more or less long term degradation in flight safety.

#### **NOTE**

draws the attention to any special item not directly related to safety but which is important or unusual.

## 1.4 DIMENSIONS

### Overall dimensions

Span	:	appr. 11.94 m	appr. 39 ft 2 in
Length	:	appr. 8.06 m	appr. 26 ft 5 in
Height	:	appr. 1.97 m	appr. 6 ft 6 in

### Wing

Airfoil	:	Wortmann FX 63-137/20 - W4	
Wing Area	:	appr. 13.54 m <sup>2</sup>	appr. 145.7 sq.ft.
Mean aerodynamic chord (MAC)	:	appr. 1.121 m	appr. 3 ft 8.1 in
Aspect ratio	:	appr. 10.53	
Dihedral	:	appr. 5°	
Leading edge sweep	:	appr. 1°	

### Aileron

Area (total, left + right)	:	appr. 0.654 m <sup>2</sup>	appr. 7.0 sq.ft.
----------------------------	---	----------------------------	------------------

### Wing flaps

Area (total, left + right)	:	appr. 1.56 m <sup>2</sup>	appr. 16.8 sq.ft.
----------------------------	---	---------------------------	-------------------

### Horizontal tail

Area	:	appr. 2.34 m <sup>2</sup>	appr. 25.2 sq.ft.
Elevator area	:	appr. 0.665 m <sup>2</sup>	appr. 7.2 sq.ft.
Angle of incidence	:	appr. -3.0° relative to longitudinal axis of airplane	

Vertical tail

Area : appr. 1.60 m<sup>2</sup>                      appr. 17.2 sq.ft.  
Rudder area : appr. 0.47 m<sup>2</sup>                      appr. 5.1 sq.ft.

Landing gear

Track : appr. 2.97 m                      appr. 9 ft 9 in

Wheelbase : appr. 1.68 m                      appr. 5 ft 6 in

Nose wheel : 5.00-5; 6 PR, 120 mph

■ Main wheel : (a) 6.00-6; 6 PR, 120 mph

■ (b) 6.00-6; 8 PR, 120 mph

■ (c) 15x6.0-6, 6 PR, 120 mph (OÄM 40-124; approved only  
■ in combination with MÄM 40-123, main landing gear strut  
■ with 18 mm / 0.71" thickness)

## 1.5 DEFINITIONS AND ABBREVIATIONS

### (a) Airspeeds

- CAS: Calibrated Airspeed. Indicated airspeed, corrected for installation and instrument errors. CAS equals TAS at standard atmospheric conditions (ISA) at MSL.
- KCAS: CAS in knots.
- KIAS: IAS in knots.
- IAS: Indicated Airspeed as shown on an airspeed indicator.
- TAS: True Airspeed. The speed of the airplane relative to the air. TAS is CAS corrected for errors due to altitude and temperature.
- $V_A$ : Maneuvering Speed. Full or abrupt control surface movement is not permissible above this speed.
- $V_C$ : Design Cruising Speed. This speed may be exceeded only in smooth air, and then only with caution.
- $V_{FE}$ : Maximum Flaps Extended Speed. This speed must not be exceeded with the given flap setting.
- $V_{NE}$ : Never Exceed Speed in smooth air. This speed must not be exceeded in any operation.
- $V_{NO}$ : Maximum Structural Cruising Speed. This speed may be exceeded only in smooth air, and then only with caution.



- $v_S$ : Stalling Speed, or the minimum continuous speed at which the airplane is still controllable in the given configuration.
- $v_{S0}$ : Stalling Speed, or the minimum continuous speed at which the airplane is still controllable in the landing configuration.
- $v_x$ : Best Angle-of-Climb Speed.
- $v_y$ : Best Rate-of-Climb Speed.

(b) Meteorological terms

ISA: International Standard Atmosphere. Conditions at which air is identified as an ideal dry gas. The temperature at mean sea level is 15 °C (59 °F), air pressure at MSL is 1,013.25 hPa (29.92 inHg); the temperature gradient up to the altitude at which the temperature reaches -56.5 °C (-69.7 °F) is -0.0065 °C/m (-0.00357 °F/ft), and above this 0 °C/m (0 °F/ft).

MSL: Mean Sea Level.

OAT: Outside Air Temperature.

QNH: Theoretical atmospheric pressure at MSL, calculated from the elevation of the measuring point above MSL and the actual atmospheric pressure at the measuring point.

Density Altitude:

Altitude in ISA conditions at which the air density is equal to the current air density.

Indicated Pressure Altitude:

Altitude reading with altimeter set to 1,013.25 hPa (29.92 inHg).

**Pressure Altitude:**

Altitude above MSL, indicated by a barometric altimeter which is set to 1,013.25 hPa (29.92 inHg). The Pressure Altitude is the Indicated Pressure Altitude corrected for installation and instrument errors.

In this Airplane Flight Manual altimeter instrument errors are regarded as zero.

**Wind:** The wind speeds which are shown as variables in the diagrams in this manual should be regarded as headwind or tailwind components of the measured wind.

**(c) Flight performance and flight planning****Demonstrated Crosswind Component:**

The speed of the crosswind component at which adequate maneuverability for take-off and landing has been demonstrated during type certification.

**MET:** Weather, weather advice.

**NAV:** Navigation, route planning.

(d) Mass and balance

**CG:** Center of Gravity, also called 'center of mass'. Imaginary point in which the airplane mass is assumed to be concentrated for mass and balance calculations. Its distance from the Datum Plane is equal to the Center of Gravity Moment Arm.

**Center of Gravity Moment Arm:**

The Moment Arm which is obtained if one divides the sum of the individual moments of the airplane by its total mass.

**Center of Gravity Limits:**

The Center of Gravity range within which the airplane, at a given mass, must be operated.

**DP:** Datum Plane; an imaginary vertical plane from which all horizontal distances for center of gravity calculations are measured.

**Empty Mass:**

The mass of the airplane including unusable fuel, all operating consumables and the maximum quantity of oil.

**Maximum Take-off Mass:**

The maximum permissible mass for take-off.

**Maximum Landing Mass:**

The highest mass for landing conditions at the maximum descent velocity. This velocity was used in the strength calculations to determine the landing gear loads during a particularly hard landing.

**Moment Arm:**

The horizontal distance from the Datum Plane to the Center of Gravity of a component.

**Moment:** The mass of a component multiplied by its moment arm.

**Usable Fuel:**

The quantity of fuel available for flight planning.

**Unusable Fuel:**

The quantity of fuel remaining in the tank which cannot be used for flight.

**Useful Load:**

The difference between take-off mass and empty mass.

**(e) Engine**

AED: Auxiliary Engine Display

CED: Compact Engine Display

CT: Coolant Temperature

ECU: Engine Control Unit

FADEC: Full Authority Digital Engine Control

GT: Gearbox Temperature

LOAD: Engine output power in percent of max. continuous power

OP: Oil Pressure (oil pressure in the lubrication system of the engine)

OT: Oil Temperature (oil temperature in the lubrication system of the engine)

RPM: Revolutions per minute (rotational speed of the propeller)

**█ Engine Starting Fuel Temperature:**

█ Above this fuel temperature the engine may be started.

**█ Take-Off Fuel Temperature:**

█ Above this fuel temperature take off power setting is permitted.

(f) Designation of the circuit breakers on the instrument panel

*ESSENTIAL BUS:*

ESS. AV.	Essential Avionic Bus
FLAPS	Flaps
HORIZON	Artificial Horizon (Attitude Gyro)
ANNUN	Annunciator Panel
INST.1	Engine Instrument
PITOT	Pitot Heating System
LANDING	Landing Light
FLOOD	Flood Light
ESS. TIE	Bus Interconnection
MASTER CONTROL	Master Control (Avionics Main Switch, Bus Connection, Avionics Relais)

*MAIN BUS:*

PWR	Power
MAIN TIE	Bus Interconnection
FAN/OAT	Fan / Outside Air Temperature
T&B	Turn And Bank Indicator
DG	Directional Gyro
INST. LT	Instrument Lights

TAXI/MAP	Taxi Lights / Map Lights
POSITION	Position Lights
STROBE	Strobe Lights (=Anti Collision Lights, ACL)
START	Starter
XFER PUMP	Fuel Transfer Pump
AV. BUS	Avionics Bus
2. HORIZON	2 <sup>nd</sup> Artificial Horizon (2 <sup>nd</sup> Attitude Gyro)

■ *MAIN AV. BUS (MAIN AVIONIC BUS):*

■ GPS/NAV2	Global Positioning System and NAV Receiver No. 2
■ COM2	COM Radio No. 2
■ AUTO PILOT	Auto Pilot System
■ ADF	Automatic Direction Finder
■ DME	Distance Measuring Equipment
■ Wx500	Stormscope
■ AUDIO	Audio Panel

*ESSENTIAL AV. BUS:*

COM1	COM Radio No. 1
GPS/NAV1	Global Positioning System and NAV Receiver No. 1
XPDR	Transponder

*ECU BUS:*

ECU ALT	ECU Alternate power relay
ECU A	ECU A
ECU B	ECU B

(g) Equipment

ELT: Emergency Locator Transmitter

(h) Design Change Advisories

MÄM: Mandatory Design Change Advisory

OÄM: Optional Design Change Advisory

(i) Miscellaneous

ACG: Austro Control GmbH (formerly BAZ, Federal Office of Civil Aviation)

ATC: Air Traffic Control

CFRP: Carbon Fiber Reinforced Plastic

GFRP: Glass Fiber Reinforced Plastic

JAR: Joint Aviation Requirements

JC/VP: Joint Certification/Validation Procedure

PCA: Primary Certification Authority



## 1.6 UNITS OF MEASUREMENT

### 1.6.1 CONVERSION FACTORS

Dimension	SI-Units	US Units	Conversion
Length	[mm] millimeters	[in] inches	$[mm] / 25.4 = [in]$
	[m] meters	[ft] feet	$[m] / 0.3048 = [ft]$
	[km] kilometers	[NM] nautical miles	$[km] / 1.852 = [NM]$
Volume	[l] liters	[US gal] US gallons	$[l] / 3.7854 = [US\ gal]$
		[qts] US quarts	$[l] / 0.9464 = [qts]$
Speed	[km/h] kilometers per hour	[kts] knots	$[km/h] / 1.852 = [kts]$
	[m/s] meters per second	[mph] miles per hour	$[km/h] / 1.609 = [mph]$
		[fpm] feet per minute	$[m/s] \times 196.85 = [fpm]$
Speed of rotation	[RPM] revolutions per minute		--
Mass	[kg] kilograms	[lb] pounds	$[kg] \times 2.2046 = [lb]$
Force, weight	[N] newtons	[lbf] pounds force	$[N] \times 0.2248 = [lbf]$
Pressure	[hPa] hecto-pascals	[inHg] inches of mercury	$[hPa] = [mbar]$
	[mbar] millibars	[psi] pounds per square inch	$[hPa] / 33.86 = [inHg]$
	[bar] bars		$[bar] \times 14.504 = [psi]$
Temperature	[°C] degrees Celsius	[°F] degrees Fahrenheit	$[°C] \times 1.8 + 32 = [°F]$
			$([°F] - 32) / 1.8 = [°C]$

Dimension	SI-Units	US Units	Conversion
Intensity of electric current	[A] ampères		--
Electric charge (battery capacity)	[Ah] ampère-hours		--
Electric potential	[V] volts		--
Time	[sec] seconds		--

**1.6.2 CONVERSION CHART LITERS / US GALLONS**

Liters	US Gallons
5	1.3
10	2.6
15	4.0
20	5.3
25	6.6
30	7.9
35	9.2
40	10.6
45	11.9
50	13.2
60	15.9
70	18.5
80	21.1
90	23.8
100	26.4
110	29.1
120	31.7
130	34.3
140	37.0
150	39.6
160	42.3
170	44.9
180	47.6

US Gallons	Liters
1	3.8
2	7.6
4	15.1
6	22.7
8	30.3
10	37.9
12	45.4
14	53.0
16	60.6
18	68.1
20	75.7
22	83.3
24	90.9
26	98.4
28	106.0
30	113.6
32	121.1
34	128.7
36	136.3
38	143.8
40	151.4
45	170.3
50	189.3

**1.7 THREE-VIEW DRAWING**

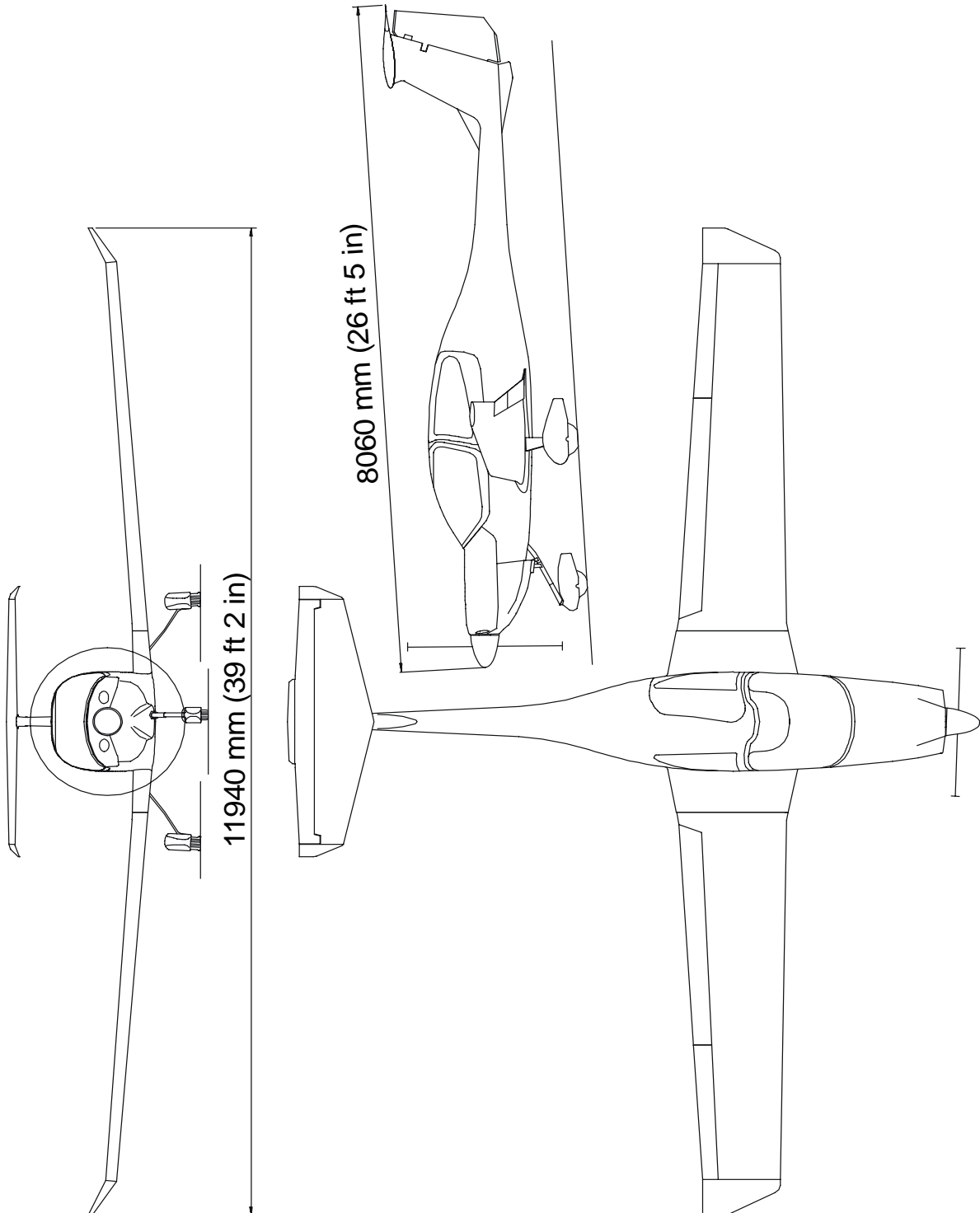

## **1.8 SOURCE DOCUMENTATION**

This section lists documents, manuals and other literature that were used as sources for the Airplane Flight Manual, and indicates the respective publisher. However, only the information given in the Airplane Flight Manual is valid.

### **1.8.1 ENGINE AND ENGINE INSTRUMENTS**

Address: Thielert Aircraft Engines GmbH  
Platanenstrasse 14  
D-09350 LICHTENSTEIN  
GERMANY

Phone: +49-37204-696-90

Fax: +49-37204-696-50

Internet: [www.thielert.com](http://www.thielert.com)

Documents: TAE 125-01 Operation and Maintenance Manual

or

TAE 125-02-99 Operation and Maintenance Manual  
(MÄM 40-256 carried out)

**1.8.2 PROPELLER**

Address: mt-propeller  
Airport Straubing Wallmühle  
D-94348 ATTING  
GERMANY

Phone: +49-9429-9409-0  
E-mail: sales@mt-propeller.com  
Internet: www.mt-propeller.de

Documents: E-124, Operation and Installation Manual  
Hydraulically controlled variable pitch propeller  
MTV -5, -6, -9, -11, -12, -14, -15, -16, -21, -22, -25

## CHAPTER 2

# OPERATING LIMITATIONS

	Page
2.1 INTRODUCTION .....	2-2
2.2 AIRSPEED .....	2-3
2.3 AIRSPEED INDICATOR MARKINGS .....	2-4
2.4 POWER-PLANT LIMITATIONS .....	2-5
2.5 ENGINE INSTRUMENT MARKINGS .....	2-8
2.6 WARNING, CAUTION AND STATUS LIGHTS .....	2-10
2.7 MASS (WEIGHT) .....	2-13
2.8 CENTER OF GRAVITY .....	2-14
2.9 APPROVED MANEUVERS .....	2-15
2.10 MANEUVERING LOAD FACTORS .....	2-17
2.11 OPERATING ALTITUDE .....	2-18
2.12 FLIGHT CREW .....	2-18
2.13 KINDS OF OPERATION .....	2-19
2.14 FUEL .....	2-23
2.15 LIMITATION PLACARDS .....	2-25
2.16 OTHER LIMITATIONS .....	2-31
2.16.1 TEMPERATURE .....	2-31
2.16.2 FUEL TEMPERATURE .....	2-31
2.16.3 DOOR LOCKING DEVICE .....	2-31
2.16.4 ELECTRONIC EQUIPMENT .....	2-32
2.16.5 SMOKING .....	2-32
2.16.6 EMERGENCY SWITCH .....	2-32
2.16.7 ECU BACKUP BATTERY .....	2-32

## **2.1 INTRODUCTION**

Chapter 2 of this Airplane Flight Manual includes operating limitations, instrument markings, and placards necessary for the safe operation of the airplane, its power-plant, standard systems and standard equipment.

The limitations included in this Chapter are approved.

### **WARNING**

Operation of the airplane outside of the approved operating limitations is not permissible.



## 2.2 AIRSPEED

	Airspeed	IAS	Remarks
V <sub>A</sub>	Maneuvering speed	108 KIAS above: 980 kg / 2161 lb up to: 1150 kg / 2535 lb  94 KIAS above: 780 kg / 1720 lb up to: 980 kg / 2161 lb	Do not make full or abrupt control surface movement above this speed.
V <sub>FE</sub>	Max. flaps extended speed	LDG: 91 KIAS T/O: 108 KIAS	Do not exceed these speeds with the given flap setting.
V <sub>NO</sub> = V <sub>C</sub>	Max. structural cruising speed	129 KIAS	Do not exceed this speed except in smooth air, and then only with caution.
V <sub>NE</sub>	Never exceed speed in smooth air	178 KIAS	Do not exceed this speed in any operation.

### **2.3 AIRSPEED INDICATOR MARKINGS**

<b>Marking</b>	<b>IAS</b>	<b>Significance</b>
White arc	49 KIAS - 91 KIAS	Operating range with flaps fully extended
Green arc	52 KIAS - 129 KIAS	Normal operating range.
Yellow arc	129 KIAS - 178 KIAS	'Caution' range - "Only in smooth air".
Red line	178 KIAS	Maximum speed for all operations - $V_{NE}$ .

## 2.4 POWER-PLANT LIMITATIONS

a) Engine manufacturer : Thielert Aircraft Engines

b) Engine designation : TAE 125-01

or

TAE 125-02-99 (if MÄM 40-256 is carried out)

c) RPM limitations (shown as propeller RPM)

	TAE 125-01	TAE 125-02-99 (MÄM 40-256 carried out)
Maximum	2500 RPM	2300 RPM
Maximum overspeed	--	2500 RPM (max. 20 sec)

d) Engine power

Max. take-off power : 99 kW (135 DIN-hp) at 2300 RPM

Max. continuous power : 99 kW (135 DIN-hp) at 2300 RPM

e) Oil pressure (indicated values are corrected for pressure altitude)

Minimum : 1.2 bar

Maximum : 6.5 bar

f) Oil quantity

Minimum : 4.5 liters (appr. 4.8 US qts)

Maximum : 6.0 liters (appr. 6.3 US qts)

Maximum oil consumption : 0.1 liters/hr (appr. 0.1 US qts/hr)

g) Oil temperature

	<b>TAE 125-01</b>	<b>TAE 125-02-99 (MÄM 40-256 carried out)</b>
Minimum	-32 °C	-32 °C
Maximum	+140 °C	+140 °C

h) Gearbox temperature

Maximum : 120 °C

i) Coolant temperature

	<b>TAE 125-01</b>	<b>TAE 125-02-99 (MÄM 40-256 carried out)</b>
Minimum	-32 °C	-32 °C
Maximum	+105 °C	+105 °C

j) Propeller manufacturer : mt-Propeller

k) Propeller designation : MTV-6-A/187-129

l) Propeller diameter : 187 cm (6 ft 2 in)

m) Propeller pitch angle (0.75 R) : 12° to 28°

n) Oil specification : SHELL HELIX ULTRA 5W-30

SHELL HELIX ULTRA 5W-40

AERO SHELL OIL Diesel 10W-40

- o) Coolant : DAI-G30-MIX (TAE 125-01 engine) or  
 DAI-G48-MIX (TAE 125-02-99 engine)  
 Water according to TAE-125-OM-02-01 / Cooler protection (BASF Glysantin Alu Protect / G30 (TAE 125-01 engine) or G48 (TAE 125-02-99 engine)) 1/1. The freezing point of the coolant is -36 °C (-32.8 °F).

### CAUTION

The use of water which does not meet the specifications according to the applicable TAE Operation Manual may cause engine damage.

### CAUTION

If the coolant level is low the reason must be determined and the problem must be corrected by authorized personnel.

- p) Gearbox oil (propeller gearbox) : SHELL EP 75W90 API GL-4

### CAUTION

If the gearbox oil level is low the reason must be determined and the problem must be corrected by authorized personnel.

- q) Maximum restart altitude : 6500 ft (TAE 125-01 engine)  
 6000 ft (TAE 125-01 R5 engine)  
 8000 ft (TAE 125-02-99 engine)

## 2.5 ENGINE INSTRUMENT MARKINGS

Engine instrument markings and their color code significance are shown in the tables below:

*If the TAE 125-01 engine is installed:*

Indication	Red arc/bar = lower prohibited range	Yellow arc/bar = caution range	Green arc/bar = normal operating range	Yellow arc/bar = caution range	Red arc/bar = upper prohibited range
RPM	--	--	up to 2400 RPM	2400 to 2500 RPM	above 2500 RPM
Oil pressure	below 1.2 bar	1.2 to 2.3 bar	2.3 to 5.2 bar	5.2 to 6.5 bar	above 6.5 bar
Oil temp.	below -32 °C	-32 to 50 °C	50 to 125 °C	125 to 140 °C	above 140 °C
Coolant temp.	below -32 °C	-32 to 60 °C	60 to 96 °C	96 to 105 °C	above 105 °C
Gearbox temp.	--	--	up to 115 °C	115 to 120 °C	above 120 °C
Load	--	--	0 - 100 %	--	--
Fuel temp.	below -30 °C	-30 to +4 °C	+5 to 69 °C	70 to 75 °C	above 75 °C
Ammeter	--	--	up to 85 A	85 to 90 A	above 90 A
Volt-meter	below 11 V	11 to 12.6 V	12.6 to 15.0 V	15.0 to 15.5 V	above 15.5 V
Fuel qty.	below 0.45 US gal	--	0.45 to 14 US gal	--	--

If the TAE 125-02-99 engine and the AED/CED Engine Instrument are installed  
 (MÄM 40-256 & OÄM 40-293 are carried out):

Indi- cation	Red arc/bar = lower prohibited range	Yellow arc/bar = caution range	Green arc/bar = normal operating range	Yellow arc/bar = caution range	Red arc/bar = upper prohibited range
RPM	--	--	0-2300 RPM	--	above 2300 RPM
Oil pressure	below 1.2 bar	1.2 to 2.3 bar	2.3 to 5.2 bar	5.2 to 6.5 bar	above 6.5 bar
Oil temp.	below -32 °C	-32 to 50 °C	50 to 125 °C	125 to 140 °C	above 140 °C
Coolant temp.	below -32 °C	-32 to 60 °C	60 to 96 °C	96 to 105 °C	above 105 °C
Gearbox temp.	--	--	up to 115 °C	115 to 120 °C	above 120 °C
Load	--	--	0 - 100 %	--	--
Fuel temp.	below -30 °C	-30 to +4 °C	+5 to 69 °C	70 to 75 °C	above 75 °C
Ammeter	--	--	up to 85 A	85 to 90 A	above 90 A
Volt- meter	below 11 V	11 to 12.6 V	12.6 to 15.0 V	15.0 to 15.5 V	above 15.5 V
Fuel qty.	below 0.45 US gal	--	0.45 to 14 US gal	--	--

From -30 °C to -6 °C the lower yellow bar of the fuel temp bar flashes, from -5 °C to +4 °C the lower yellow bar of the fuel temp is continuously on. This applies only to conventional instrument panel versions.

## 2.6 WARNING, CAUTION AND STATUS LIGHTS

The following tables show the color and significance of the warning, caution and status lights on the annunciator panel.

### NOTE

The ECU BACKUP UNSAFE warning light is located above the airspeed indicator on the instrument panel.

### NOTE

Section 7.10 includes a detailed description of the lights on the annunciator panel.

#### Color and significance of the warning lights (red)

Warning light (red)	Meaning	Cause
WARNING	Warning message	--
START	Starter	Operation of starter, or failure of the starter motor to disengage from the engine after starting
DOOR	Doors	Front canopy and/or rear door not completely closed and locked
TRIM FAIL	Trim fail / autopilot	Failure in the automatic trim system of the autopilot (if installed)
ECU BACKUP UNSAFE	ECU Backup Battery	ECU Backup Battery has less than 70% electric charge.



Color and significance of the caution lights (amber)

Caution light (amber)	Meaning	Cause
CAUTION	Caution message	--
LOW VOLTS	Low voltage	On-board voltage below 12.6 V ( $\pm 0.2$ V)
ALTERNATOR	Generator	Generator failure
PITOT	Pitot heating	Pitot heating OFF or failure
LOW FUEL	Low fuel	MAIN tank, fuel low
ENGINE	Engine	Engine limit exceeded
ECU A	ECU A	A fault has occurred in the ECU A (one reset of minor faults is possible) or ECU A is being tested during the ECU-test procedure during the 'before take-off-check'.
ECU B	ECU B	A fault has occurred in the ECU B (one reset of minor faults is possible) or ECU B is being tested during the ECU-test procedure during the 'before take-off-check'.

Color and significance of the status lights (white)

Status light (white)	Meaning	Cause
FUEL TRANS	Transfer pump	Transfer pump active / fuel transfer from the AUX tank to the MAIN tank
GLOW	Glow plugs	Glow plugs active

## **2.7 MASS (WEIGHT)**

Maximum take-off mass (Normal Category)	:	1150 kg	(2535 lb)
Maximum take-off mass (Utility Category)	:	980 kg	(2161 lb)
Maximum landing mass	:	1150 kg	(2535 lb)
			if landing gear struts with 18 mm (0.71 in) thickness are installed (if MÄM 40-123 is carried out).
		1092 kg	(2407 lb) otherwise
Max. load in baggage compartment	:	30 kg	(66 lb)

### **WARNING**

Exceeding the mass limits will lead to an overstressing of the airplane as well as to a degradation of flight characteristics and flight performance.

### **NOTE**

The maximum landing mass is the highest mass for landing conditions at the maximum descent velocity. This velocity was used in the strength calculations to determine the landing gear loads during a particularly hard landing.

## 2.8 CENTER OF GRAVITY

### Datum Plane

The Datum Plane (DP) is a plane which is normal to the airplane's longitudinal axis and in front of the airplane as seen from the direction of flight. The airplane's longitudinal axis is parallel with the upper surface of a 600:31 wedge which is placed on top of the rear fuselage in front of the vertical stabilizer. When the upper surface of the wedge is aligned horizontally, the Datum Plane is vertical. The Datum Plane is located 2.194 meters (86.38 in) forward of the most forward point of the root rib on the stub wing.

### Center of gravity limitations

The center of gravity (CG position) for flight conditions must be between the following limits:

Most forward CG:

- 2.40 m (94.5 in) aft of DP from 780 kg to 980 kg (1720 lb to 2161 lb)
- 2.46 m (96.9 in) aft of DP at 1150 kg (2535 lb)
- linear variation between these values

Most rearward CG:

- Standard tank: 2.59 m (102.0 in) aft of DP
- Long Range Tank: 2.55 m (100.4 in) aft of DP

## **WARNING**

Exceeding the center of gravity limitations reduces the controllability and stability of the airplane.

## **2.9 APPROVED MANEUVERS**

The airplane is certified in the Normal Category and in the Utility Category in accordance with JAR-23.

### Approved maneuvers

#### *a) Normal Category:*

- 1) all normal flight maneuvers;
- 2) stalling (with the exception of dynamic stalling); and
- 3) Lazy Eights, Chandelles, as well as steep turns and similar maneuvers, in which an angle of bank of not more than 60° is attained.

### **CAUTION**

Aerobatics, spinning, and flight maneuvers with more than 60° of bank are not permitted in the Normal Category.

*b) Utility Category:*

- 1) all normal flight maneuvers;
- 2) stalling (with the exception of dynamic stalling); and
- 3) Lazy Eights, Chandelles, as well as steep turns and similar maneuvers, in which an angle of bank of not more than 90° is attained.

**CAUTION**

Aerobatics, spinning, and flight maneuvers with more than 90° of bank are not permitted in the Utility Category.

**CAUTION**

The accuracy of the attitude gyro (artificial horizon) and the directional gyro is affected by the maneuvers approved under item 3 if the bank angle exceeds 60°. Such maneuvers may therefore only be flown when the above mentioned instruments are not required for the present kind of operation.

## 2.10 MANEUVERING LOAD FACTORS

### **NOTE**

The tables below show structural limitations. The load factor limits for the TAE 125-01 engine or TAE 125-02-99 engine (if MÄM 40-256 is carried out) must also be observed. Refer to the Operation & Maintenance Manual for the engine.

### **CAUTION**

Avoid extended negative g-loads duration. Extended negative g-loads can cause propeller control problems and engine surging.

Table of maximum structural load factors:

#### Normal Category

	at $v_A$	at $v_{NE}$	with flaps in T/O or LDG position
Positive	3.8	3.8	2.0
Negative	-1.52	0	

#### Utility Category

	at $v_A$	at $v_{NE}$	with flaps in T/O or LDG position
Positive	4.4	4.4	2.0
Negative	-1.76	-1.0	

### **WARNING**

Exceeding the maximum load factors will lead to an overstressing of the airplane.

Doc. # 6.01.05-E	Revision 5    01-Jun-2008	Page 2 - 17
------------------	---------------------------	-------------

## **2.11 OPERATING ALTITUDE**

The maximum demonstrated operating altitude is 16400 ft (5000 m) pressure altitude.

## **2.12 FLIGHT CREW**

Minimum crew : 1 (one person)

Maximum number of occupants

Normal Category : 4 (four persons)

Utility Category : 2 (two persons, both must sit in front)



## **2.13 KINDS OF OPERATION**

Approved are :

- \* flights according to Visual Flight Rules (VFR)
- \* flights according to Night Visual Flight Rules (NVFR)
- \* flights according to Instrument Flight Rules (IFR)

Flights into known or forecast icing conditions are prohibited.

Flights into known thunderstorms are prohibited.

### Minimum operational equipment (serviceable)

The following table lists the minimum serviceable equipment required by JAR-23 and operational requirements. Additional minimum equipment for the intended operation may be required by national operating rules and also depends on the route to be flown.

	<b>for daytime VFR flights</b>	<b>in addition for night VFR flights</b>	<b>in addition for IFR flights</b>
Flight and navigation instruments	<ul style="list-style-type: none"> <li>* airspeed indicator</li> <li>* altimeter</li> <li>* magnetic compass</li> </ul>	<ul style="list-style-type: none"> <li>* vertical speed indicator (VSI)</li> <li>* attitude gyro (artificial horizon)</li> <li>* turn &amp; bank indicator</li> <li>* directional gyro</li> <li>* OAT indicator</li> <li>* chronometer with indication of hours, minutes, and seconds</li> <li>* VHF radio (COM)</li> <li>* VOR receiver</li> <li>* transponder (XPDR), mode A and mode C</li> <li>* 1 headset (2 headsets if PM 1000 Intercom is installed)</li> </ul>	<ul style="list-style-type: none"> <li>* second VHF radio (COM)</li> <li>* VOR-LOC-GS receiver</li> <li>* marker beacon receiver</li> </ul>

	for daytime VFR flights	in addition for night VFR flights	in addition for IFR flights
engine instruments	<ul style="list-style-type: none"> <li>* fuel quantity</li> <li>* oil pressure</li> <li>* oil temperature</li> <li>* coolant temperature</li> <li>* gear box temperature</li> <li>* load</li> <li>* propeller RPM</li> <li>* fuel temperature left &amp; right tank</li> <li>* engine caution light (on White Wire)</li> </ul>	<ul style="list-style-type: none"> <li>* ammeter</li> <li>* voltmeter</li> </ul>	
lighting		<ul style="list-style-type: none"> <li>* position lights</li> <li>* strobe lights (anti collision lights)</li> <li>* landing light</li> <li>* instrument lighting</li> <li>* flood light</li> <li>* flashlight</li> </ul>	

	<b>for daytime VFR flights</b>	<b>in addition for night VFR flights</b>	<b>in addition for IFR flights</b>
other operational minimum equipment	<ul style="list-style-type: none"> <li>* stall warning system</li> <li>* fuel quantity measuring device (see 7.9 of the AFM)</li> <li>* safety belts for each occupied seat</li> <li>* airplane flight manual</li> </ul>	<ul style="list-style-type: none"> <li>* Pitot heating system</li> <li>* alternate static valve</li> </ul>	<ul style="list-style-type: none"> <li>* emergency battery for horizon/ flood light</li> <li>* ECU-Backup Unsafe Warning Light</li> </ul>

**NOTE**

A list of approved equipment can be found in Chapter 6.

## 2.14 FUEL

- | Approved fuel grades : JET A-1 (ASTM D 1655)
- | JET A (ASTM D 1655)
- | JET Fuel No. 3 (GB6537-94)
- | Diesel Fuel (EN590) and
- | blends of the above listed Fuel grades:
- | see CAUTIONS below

### **CAUTION**

Additional temperature limitations must be observed if the airplane is operated with Diesel Fuel or blends of Diesel Fuel with JET Fuel.

### **CAUTION**

Limitations for operation in the following countries:  
 Indonesia, Malaysia: Use of Diesel Fuel is NOT approved.

### **NOTE**

Use only uncontaminated fuel from reliable sources.

Standard tank:

Total fuel quantity : 2 x 15.0 US gal (2 x 56.8 liters)

Usable fuel : 2 x 14.0 US gal (2 x 53.0 liters)

Long Range Tank:

Total fuel quantity : 2 x 20.5 US gal (2 x 77.6 liters)

Usable fuel : 2 x 19.5 US gal (2 x 73.8 liters)

Max. indicated fuel quantity : 15 US gal (56.8 liters) per tank

Max. permissible difference  
between right and left tank : 9 US gal (approx. 34 liters)

**CAUTION**

If an indicator shows 15 US gal, then 19.5 US gal must be assumed for the calculation of the difference between right and left tank.

## 2.15 LIMITATION PLACARDS

All *limitation* placards are shown below. A list of *all* placards is included in the Airplane Maintenance Manual (Doc. No. 6.02.01), Chapter 11.

On the instrument panel:

### Maneuvering speed:

$v_A = 108$  KIAS (above 980 up to 1150 kg / above 2161 up to 2535 lb)

$v_A = 94$  KIAS (780 to 980 kg / 1720 to 2161 lb)

This airplane may only be operated in accordance with the Airplane Flight Manual. It can be operated in the "Normal" and "Utility" categories in non-icing conditions. Provided that national operational requirements are met and the appropriate equipment is installed, this airplane is approved for the following kinds of operation: day VFR, night VFR and IFR. All aerobatic maneuvers including spinning are prohibited. For further operational limitations refer to the Airplane Flight Manual.

**No smoking.**

*If KAP 140 Autopilot system is installed (OÄM 40-153 carried out):*

### Limitations for KAP 140 Autopilot System:

Do not use AP if "Alternate Static" is open.

Conduct AP and trim check prior to each flight (see AFM).

Autopilot OFF during take-off and landing.

Maximum speed for autopilot operation is 165 KIAS.

Minimum speed for autopilot operation is 70 KIAS.

Minimum altitude for autopilot operation:

Cruise, Climb, Descent and Maneuvering: 800 feet AGL

Approach: 200 feet AGL

- | If the No. 2 Course Deviation Indicator (CDI) is installed on the co-pilot's side
- | (OÄM 40-214 or OÄM 40-153 carried out):

**NAV No. 2 not approved  
for precision approaches.**

On the instrument panel, next to the fuel quantity indication:  
Long Range Tank:

**max. usable fuel: 2 x 19.5 US gal**  
\* Max. indicated fuel quantity: 2 x 15 US gal  
\* Refer to AFM to use entire tank capacity  
\* Max. difference LH/RH tank: 9 US gal

- | On the conventional instrument panel, next to the fuel temperature indication:

**Diesel Fuel or Unknown Fuel Blend:**

Yellow blinking:	No engine start permitted
Yellow steady on (LH fuel tank):	No take-off permitted



Next to each of the two fuel filler necks:

**WARNING**

**APPROVED FUEL:**

**JET A-1**

**or see Airplane Flight Manual**

On Airplanes with early serial numbers the placard may include "Diesel EN590".

Next to the essential bus switch:

**Ess. Bus NOT for normal operation. See AFM.**

In the cowling, on the door for the oil filler neck:

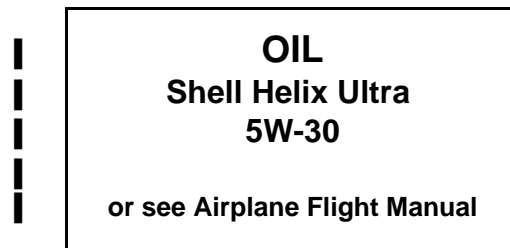

Next to the flap selector switch:

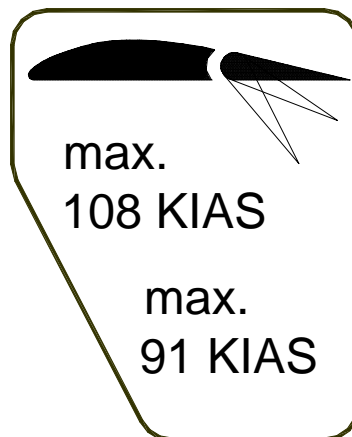

On the emergency fuel valve:

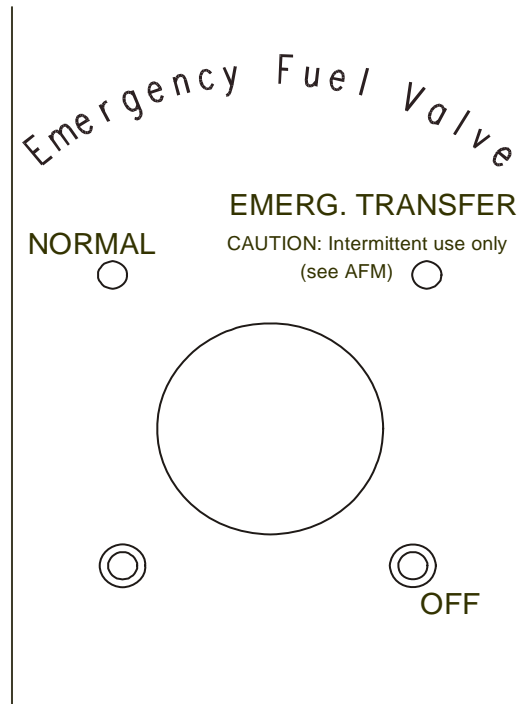

In the cockpit, on the left fuselage sidewall:

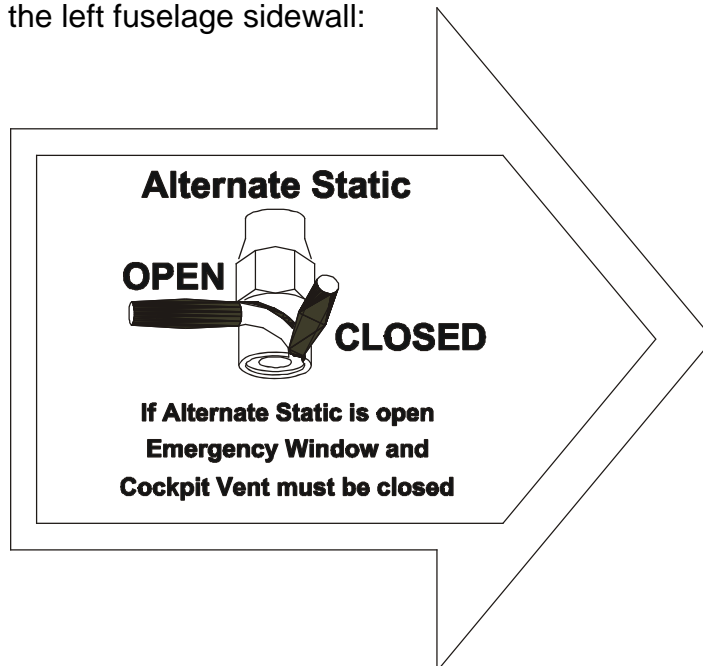

Next to the baggage compartment:



Beside the door locking device:

**EMERGENCY EXIT:**  
The keylock must be  
unlocked during flight

## **2.16 OTHER LIMITATIONS**

### **2.16.1 TEMPERATURE**

- The airplane may only be operated when its temperature prior to operation is not less than -20 °C (-4 °F) and not higher than 54 °C (129 °F) .
- With the airplane cold soaked and its temperature below -20 °C (-4 °F) the use of an external pre-heater for the engine and pilot compartment prior to operation is mandatory.

### **2.16.2 FUEL TEMPERATURE**

JET A-1, JET A, JET Fuel No. 3 and blends of JET Fuel:

TAE 125-01 engine:	from -30 °C to +65 °C (from -22 °F to +149 °F)
TAE 125-02-99 engine (MÄM 40-256 carried out):	from -30 °C to +75 °C (from -22 °F to +167 °F)

Diesel Fuel, blends of Jet Fuel with Diesel Fuel or unknown fuel blend:

Engine starting fuel temperature:	min. -5 °C (+23 °F)
Take-off fuel temperature left:	min. +5 °C (+41 °F)
Maximum fuel temperature:	
TAE 125-01 engine:	+65 °C (+149 °F)
TAE 125-02-99 engine (MÄM 40-256 carried out):	+75°C (+167 °F)

### **2.16.3 DOOR LOCKING DEVICE**

The canopy and the passenger door must not be locked during operation of the airplane.

#### **2.16.4 ELECTRONIC EQUIPMENT**

The use and switching on of electronic equipment other than that which is part of the equipment of the airplane is not permitted, as it could lead to interference with the airplane's avionics.

Examples of undesirable items of equipment are:

- Mobile telephones
- Remote radio controls
- Video screens employing CRTs
- Minidisc recorders when in the record mode

This list is not exhaustive.

The use of laptop computers, including those with CD-ROM drives, CD and minidisc players in the replay mode, cassette players and video cameras is permitted. All this equipment however should be switched off for take-off and landing.

#### **2.16.5 SMOKING**

Smoking in the airplane is not permitted.

#### **2.16.6 EMERGENCY SWITCH**

IFR flights are not permitted when the seal on the EMERGENCY switch is broken.

#### **2.16.7 ECU BACKUP BATTERY**

- The 'ECU BACKUP UNSAFE'-light (red) indicates an insufficient backup battery charge.
- IFR-flights are not permitted.

## CHAPTER 3

# EMERGENCY PROCEDURES

	Page
3.1 INTRODUCTION .....	3-3
3.1.1 GENERAL .....	3-3
3.1.2 CERTAIN AIRSPEEDS IN EMERGENCIES .....	3-4
3.2 ENGINE PROBLEMS .....	3-5
3.2.1 ENGINE PROBLEMS ON GROUND .....	3-5
3.2.2 ENGINE PROBLEMS DURING TAKE-OFF .....	3-6
3.2.3 ENGINE PROBLEMS IN FLIGHT .....	3-8
3.2.4 RESTARTING THE ENGINE WITH WINDMILLING PROPELLER .....	3-11
3.2.5 RESTARTING THE ENGINE WITH STATIONARY PROPELLER .....	3-13
3.2.6 DEFECTIVE RPM REGULATING SYSTEM .....	3-15
3.2.7 FUEL TRANSFER PUMP FAILURE .....	3-18
3.3 SMOKE AND FIRE .....	3-19
3.3.1 SMOKE AND FIRE ON GROUND .....	3-19
3.3.2 SMOKE AND FIRE DURING TAKE-OFF .....	3-20
3.3.3 SMOKE AND FIRE IN FLIGHT .....	3-22
3.4 GLIDING .....	3-24
3.5 EMERGENCY LANDINGS .....	3-25
3.5.1 EMERGENCY LANDING WITH ENGINE OFF .....	3-25
3.5.2 LANDING WITH A DEFECTIVE TIRE ON THE MAIN LANDING GEAR .....	3-26

3.5.3	LANDING WITH DEFECTIVE BRAKES .....	3-27
3.6	RECOVERY FROM AN UNINTENTIONAL SPIN .....	3-28
3.7	OTHER EMERGENCIES .....	3-29
3.7.1	ICING .....	3-29
3.7.2	FAILURES IN THE ELECTRICAL SYSTEM .....	3-30
3.7.3	SUSPICION OF CARBON MONOXIDE CONTAMINATION IN THE CABIN .....	3-32
3.7.4	'DOOR'-WARNING LIGHT ON .....	3-33

**NOTE**

Procedures for uncritical system faults are given in Chapter  
4B - ABNORMAL OPERATING PROCEDURES.



## **3.1 INTRODUCTION**

### **3.1.1 GENERAL**

This Chapter contains checklists as well as the description of recommended procedures to be followed in the event of an emergency. Engine failure or other airplane-related emergencies are most unlikely to occur if the prescribed procedures for pre-flight checks and airplane maintenance are followed.

If, nonetheless, an emergency does arise, the guidelines given here should be followed and applied in order to clear the problem.

As it is impossible to foresee all kinds of emergencies and cover them in this Airplane Flight Manual, a thorough understanding of the airplane by the pilot is, in addition to his knowledge and experience, an essential factor in the solution of any problems which may arise.

### **WARNING**

In each emergency, control over the flight attitude and the preparation of a possible emergency landing have priority over attempts to solve the current problem ("first fly the aircraft"). Prior to the flight the pilot must consider the suitability of the terrain for an emergency landing for each phase of the flight. For a safe flight the pilot must constantly keep a safe minimum flight altitude. Solutions for various adverse scenarios should be thought over in advance. Thus it should be guaranteed that the pilot is at no time shocked by an engine failure and that he can act calmly and with determination.

**3.1.2 CERTAIN AIRSPEEDS IN EMERGENCIES**

Event		850 kg 1874 lb	1000 kg 2205 lb	1150 kg 2535 lb
Engine failure after take-off (Flaps T/O)		59 KIAS	66 KIAS	72 KIAS
Airspeed for best glide angle (Flaps UP)		60 KIAS	68 KIAS	73 KIAS
Emergency landing with engine off	Flaps UP	60 KIAS	68 KIAS	73 KIAS
	Flaps T/O	59 KIAS	66 KIAS	72 KIAS
	Flaps LDG	58 KIAS	63 KIAS	71 KIAS

### **3.2 ENGINE PROBLEMS**

#### **3.2.1 ENGINE PROBLEMS ON GROUND**

1. Power lever ..... IDLE
2. Brakes ..... as required

#### **NOTE**

If considered necessary, the engine must be shut down. Otherwise the cause of the problem must be established in order to re-establish engine performance.

#### **CAUTION**

If the oil pressure is in the red range, the engine must be shut down immediately.

#### **WARNING**

If the problem cannot be cleared, the airplane must not be flown.

**END OF CHECKLIST**

**3.2.2 ENGINE PROBLEMS DURING TAKE-OFF**

(a) Take-off can still be aborted (sufficient runway length available)

*land straight ahead:*

1. Power lever ..... IDLE

*on the ground:*

2. Brakes ..... as required

**CAUTION**

If sufficient time is remaining, the risk of fire in the event of a collision can be reduced as follows:

- Emergency fuel valve ..... OFF
- ENGINE MASTER ..... OFF
- ELECTRIC MASTER ..... OFF

**END OF CHECKLIST**

(b) Take-off can no longer be aborted

- 1. Airspeed ..... 72 KIAS (1150 kg, 2535 lb)  
66 KIAS (1000 kg, 2205 lb)  
59 KIAS (850 kg, 1874 lb)

**WARNING**

If, in the event of an engine problem occurring during take-off, the take-off can no longer be aborted and a safe height has not been reached, then a straight-ahead emergency landing should be carried out. Do not attempt to turn back to the airfield. Turning back can be fatal.

*if time allows:*

- 2. Power lever ..... check MAX
- 3. ECU SWAP ..... ECU B

**WARNING**

If the problem does not clear itself immediately, and the engine is no longer producing sufficient power, then an emergency landing must be carried out in accordance with 3.5.1 - EMERGENCY LANDING WITH ENGINE OFF.

**END OF CHECKLIST**

**3.2.3 ENGINE PROBLEMS IN FLIGHT**

(a) Engine running roughly

1. Airspeed ..... 73 KIAS (1150 kg, 2535 lb)  
68 KIAS (1000 kg, 2205 lb)  
60 KIAS (850 kg, 1874 lb)
2. Power lever ..... MAX
3. Engine caution light ..... check

**NOTE**

If the caution light is on, the engine instruments must be checked. Proceed in accordance with 4B.2 - INSTRUMENT INDICATIONS OUTSIDE OF GREEN RANGE.

4. If in icing conditions ..... Alternate Air ON
5. Fuel qty. MAIN tank ..... check
6. Fuel transfer pump ..... ON
7. Emergency fuel valve ..... check NORMAL
8. ECU SWAP ..... ECU B

**NOTE**

If selecting ECU B does not solve the problem, switch back to AUTOMATIC.

**CONTINUED**

Page 3 - 8	Revision 5	01-Jun-2008	Doc. # 6.01.05-E
------------	------------	-------------	------------------

**WARNING**

If the problem does not clear itself immediately, and the engine is no longer producing sufficient power, perform a precautionary landing on the nearest airfield in accordance with 4B.1 - PRECAUTIONARY LANDING, but be prepared for an emergency landing in accordance with 3.5.1 - EMERGENCY LANDING WITH ENGINE OFF.

**END OF CHECKLIST**

(b) Loss of power

**NOTE**

As long as an airspeed of at least 60 KIAS is maintained, and there is no major mechanical engine defect, the propeller will continue to windmill.

- 1. Airspeed ..... 73 KIAS (1150 kg, 2535 lb)  
68 KIAS (1000 kg, 2205 lb)  
60 KIAS (850 kg, 1874 lb)
- 2. Power lever ..... MAX
- 3. If in icing conditions ..... Alternate Air ON
- 4. Fuel qty. MAIN tank ..... check
- 5. Fuel transfer pump ..... ON
- 6. Emergency fuel valve ..... check NORMAL
- 7. ECU SWAP ..... ECU B

**CONTINUED**

- | ECU reset:
- | 8. ENGINE MASTER ..... OFF - ON

**NOTE**

If selecting ECU B does not solve the problem, switch back to AUTOMATIC.

**WARNING**

If the problem does not clear itself immediately, prepare for an emergency landing in accordance with 3.5.1 - EMERGENCY LANDING WITH ENGINE OFF, then try to restart the engine with windmilling propeller in accordance with 3.2.4 - RESTARTING THE ENGINE WITH WINDMILLING PROPELLER.

**END OF CHECKLIST**



**3.2.4 RESTARTING THE ENGINE WITH WINDMILLING PROPELLER**

**NOTE**

As long as an airspeed of at least 60 KIAS is maintained, and there is no major mechanical engine defect, the propeller will continue to windmill. After a complete stop the propeller starts to windmill at airspeeds above 105 KIAS (TAE 125-01 engine) or 110 KIAS (TAE 125-02-99 engine).

**CAUTION**

The maximum airspeed for windmilling is 120 KIAS. Higher airspeeds may result in propeller overspeed.

**NOTE**

Restarting the engine with windmilling propeller is possible at airspeeds between 73 and 120 KIAS (TAE 125-01 engine) or 110 KIAS (TAE 125-01 R5 engine) and altitudes below 6500 ft (TAE 125-01 engine) or 6000 ft (TAE 125-01 R5 engine) or 8000 ft (TAE 125-02-99 engine) pressure altitude.

- 1. Airspeed for best glide angle . . . . . 73 KIAS (1150 kg, 2535 lb)  
68 KIAS (1000 kg, 2205 lb)  
60 KIAS (850 kg, 1874 lb)
- 2. Power lever . . . . . IDLE
- 3. Emergency fuel valve . . . . . check NORMAL
- 4. Alternate air . . . . . OPEN
- 5. Fuel transfer pump . . . . . ON
- 6. AVIONIC MASTER . . . . . OFF

**CONTINUED**

- 7. ELECTRIC MASTER ..... ON
- 8. Airspeed ..... 73 to 120 KIAS

█ ECU reset:

- █ 9. ENGINE MASTER ..... OFF - ON

### NOTE

If it is not possible to start the engine:

- adopt glide configuration as in 3.4 - GLIDING
- carry out emergency landing in accordance with  
3.5.1 - EMERGENCY LANDING WITH ENGINE OFF

### CAUTION

█ Engine restart following an engine fire should only be attempted if it is unlikely that a safe emergency landing can be made. It must be expected that engine restart is impossible after an engine fire.

- 10. AVIONIC MASTER ..... ON, if required

**END OF CHECKLIST**

### 3.2.5 RESTARTING THE ENGINE WITH STATIONARY PROPELLER

#### NOTE

Restarting the engine with stationary propeller is possible at altitudes below 6500 ft (TAE 125-01 engine) or 6000 ft (TAE 125-01 R5 engine) or 8000 ft (TAE 125-02-99 engine) pressure altitude.

- |    |                               |                            |
|----|-------------------------------|----------------------------|
| 1. | Airspeed for best glide angle | 73 KIAS (1150 kg, 2535 lb) |
|    |                               | 68 KIAS (1000 kg, 2205 lb) |
|    |                               | 60 KIAS (850 kg, 1874 lb)  |
| 2. | ENGINE MASTER                 | OFF                        |
| 3. | Power lever                   | IDLE                       |
| 4. | Emergency fuel valve          | check NORMAL               |
| 5. | Alternate air                 | OPEN                       |
| 6. | Fuel transfer pump            | ON                         |
| 7. | AVIONIC MASTER                | OFF                        |
| 8. | ELECTRIC MASTER               | ON                         |
| 9. | ENGINE MASTER                 | ON                         |

#### NOTE

Only if the ENGINE MASTER is switched OFF and ON again, glowing will be initiated. Glowing must be initiated shortly before the restart attempt. If glowing was done above 6500 ft (TAE 125-01 engine) or 6000 ft (TAE 125-01 R5 engine) or 8000 ft (TAE 125-02-99 engine) pressure altitude, it must be repeated.

**CONTINUED**

10. ELECTRIC MASTER ..... START (release when engine is running)

### NOTE

By increasing the airspeed above approximately 105 KIAS (TAE 125-01 engine) or 110 KIAS (TAE 125-02-99 engine), the propeller will begin to rotate due to windmilling and the engine can thus be started. For this, the ELECTRIC MASTER should be set to ON (see 3.2.4 - RESTARTING THE ENGINE WITH WINDMILLING PROPELLER). A loss of altitude of at least 1000 ft (300 meters) must be expected.

If it is not possible to start the engine:

- adopt glide configuration as in 3.4 - GLIDING
- carry out emergency landing as in 3.5.1 - EMERGENCY LANDING WITH ENGINE OFF

### CAUTION

Engine restart following an engine fire should only be attempted if it is unlikely that a safe emergency landing can be made. It must be expected that engine restart is impossible after an engine fire.

**END OF CHECKLIST**

**3.2.6 DEFECTIVE RPM REGULATING SYSTEM**

**CAUTION**

Following a failure of the governor the RPM should be adjusted with the power lever. Every effort should be made not to exceed 2500 RPM.

**CAUTION**

The power lever should be moved slowly, in order to avoid over-speeding and excessively rapid RPM changes. The light wooden propeller blades produce more rapid RPM changes than metal blades.

**WARNING**

It is possible that the propeller blades remain in the position of highest pitch in case of a malfunction of the engine control unit. In this case the reduced engine performance should be anticipated.

**(a) Oscillating RPM**

1. Power setting ..... change

*if the problem does not clear:*

2. ECU SWAP ..... ECU B

**NOTE**

If the problem does not clear itself, switch back to AUTOMATIC and land on the nearest airfield.

**END OF CHECKLIST**

Doc. # 6.01.05-E	Revision 5      01-Jun-2008	Page 3 - 15
------------------	-----------------------------	-------------

(b) Propeller overspeed

**NOTE**

Constant propeller overspeed indicates that the defective governor holds the propeller blades at the fine pitch stop.

**NOTE**

The propeller now works like a fixed pitch propeller. RPM is controlled by the engine power setting. Flight to the nearest airfield can be continued with a lower power setting and at a lower airspeed. Climb and go-around remain possible.

1. Power lever ..... as required to maintain 2300 RPM
2. ECU SWAP ..... ECU B

**NOTE**

If selecting ECU B does not solve the problem, switch back to AUTOMATIC. Keep controlling the RPM with the power lever.

**END OF CHECKLIST**

(c) Propeller underspeed

**NOTE**

The propeller speed is constantly below the speed that is correct for the given power setting. This indicates that the governor holds the propeller blades at the high pitch stop.

1. Power lever ..... as required
2. ECU SWAP ..... ECU B

**NOTE**

If selecting ECU B does not solve the problem, switch back to AUTOMATIC.

**WARNING**

Due to this problem the propeller RPM will drop to 1400 RPM or below. There will be no climb performance and no go-around power available. Level flight should be possible except in rough weather.

3. Land as soon as possible.

**END OF CHECKLIST**

**3.2.7 FUEL TRANSFER PUMP FAILURE**

1. Emergency fuel valve ..... EMERG. TRANSFER

**CAUTION**

When set to EMERG. TRANSFER, the emergency fuel valve transfers fuel using the engine driven fuel pump from the auxiliary tank to the main tank at a rate of approximately 18 to 21 US gal/h (70 to 80 liters/h).

**WARNING**

The emergency fuel valve must be switched back to NORMAL before the auxiliary tank indication reads zero! Otherwise, the engine will stop during flight when the auxiliary tank is empty.

**WARNING**

When the fuel pump takes in air (e.g. when the emergency fuel valve is not switched back and the auxiliary tank is empty), an inspection of the pump is necessary prior to next flight.

2. AUX tank ..... monitor quantity
3. MAIN tank ..... monitor quantity

**NOTE**

AUX tank quantity must not be less than 1 US gal and MAIN tank quantity must not be more than 15 US gal.

4. Emergency fuel valve ..... NORMAL

**END OF CHECKLIST**

Page 3 - 18	Revision 5    01-Jun-2008	Doc. # 6.01.05-E
-------------	---------------------------	------------------



**3.3 SMOKE AND FIRE**

**3.3.1 SMOKE AND FIRE ON GROUND**

(a) Engine fire when starting on the ground

- 1. Emergency fuel valve ..... OFF
- 2. Fuel transfer pump ..... OFF
- 3. ENGINE MASTER ..... OFF
- 4. ELECTRIC MASTER ..... OFF

*after standstill:*

- 5. Canopy ..... open
- 6. Airplane ..... evacuate immediately

**END OF CHECKLIST**

(b) Electrical fire with smoke on the ground

- 1. ELECTRIC MASTER ..... OFF

*if the engine is running:*

- 2. Power lever ..... IDLE
- 3. ENGINE MASTER ..... OFF

*when the engine has stopped:*

- 4. Canopy ..... open
- 5. Airplane ..... evacuate immediately

**END OF CHECKLIST**

**3.3.2 SMOKE AND FIRE DURING TAKE-OFF**

(a) If take-off can still be aborted

1. Power lever ..... IDLE
2. Cabin heat ..... OFF
3. Brakes ..... apply - bring the airplane to a stop
4. After stopping ..... proceed as in 3.3.1 - SMOKE AND FIRE ON GROUND

**END OF CHECKLIST**

(b) If take-off cannot be aborted

1. Cabin heat ..... OFF
2. If possible, fly along a short-cut traffic circuit and land on the airfield.

**WARNING**

If, in the event of an engine problem occurring during take-off, the take-off can no longer be aborted and a safe height has not been reached, then a straight-ahead emergency landing should be carried out. Do not attempt to turn back to the airfield. Turning back can be fatal.

3. Airspeed ..... 73 KIAS (1150 kg, 2535 lb)  
68 KIAS (1000 kg, 2205 lb)  
60 KIAS (850 kg, 1874 lb)

**CONTINUED**

*after climbing to a height from which the selected landing area can be reached safely:*

4. Emergency fuel valve . . . . . OFF
5. Fuel transfer pump . . . . . OFF
6. Cabin heat . . . . . OFF
7. ENGINE MASTER . . . . . OFF
8. ELECTRIC MASTER . . . . . OFF
9. Emergency windows . . . . . open if necessary
10. Carry out emergency landing with engine off. Allow for increased landing distance due to the flap position.

### CAUTION

In case of extreme smoke development, the front canopy may be unlatched during flight. This allows it to partially open, in order to improve ventilation. The canopy will remain open in this position. Flight characteristics will not be affected significantly.

■ *when airplane has stopped:*

- 11. Canopy . . . . . open
- 12. Airplane . . . . . evacuate immediately

**END OF CHECKLIST**

**3.3.3 SMOKE AND FIRE IN FLIGHT**

**WARNING**

In the event of smoke or fire, prepare to land the airplane without delay while completing fire suppression and/or smoke evacuation procedures. If it cannot be visually verified that the fire has been completely extinguished, whether the smoke has cleared or not, land immediately.

(a) Engine fire in flight

1. Cabin heat . . . . . OFF
2. Select appropriate emergency landing area.

*when it seems certain that the landing area will be reached:*

3. Emergency fuel valve . . . . . OFF
4. Power lever . . . . . MAX
5. Emergency windows . . . . . open if required
6. Carry out emergency landing with engine off.

**CAUTION**

In case of extreme smoke development, the front canopy may be unlatched during flight. This allows it to partially open, in order to improve ventilation. The canopy will remain open in this position. Flight characteristics will not be affected significantly.

*when airplane has stopped:*

7. Canopy . . . . . open
8. Airplane . . . . . evacuate immediately

**END OF CHECKLIST**

(b) Electrical fire with smoke in flight

- 1. EMERGENCY switch . . . . . ON, if installed
- 2. AVIONIC MASTER . . . . . OFF
- 3. ELECTRIC MASTER . . . . . OFF
- 4. Cabin heat . . . . . OFF
- 5. Emergency windows . . . . . open if required
- 6. Land at an appropriate airfield immediately

**WARNING**

Switching OFF the ELECTRIC MASTER will lead to total failure of all electronic and electric equipment. Also affected from this are the attitude gyro (artificial horizon) and the directional gyro, if installed.

However, by switching the EMERGENCY switch ON, the emergency battery will supply power to the attitude gyro (artificial horizon) and the flood light.

In case of extreme smoke development, the front canopy may be unlatched during flight. This allows it to partially open, in order to improve ventilation. The canopy will remain open in this position. Flight characteristics will not be affected significantly.

*when airplane has stopped:*

- 7. Canopy . . . . . open
- 8. Airplane . . . . . evacuate immediately

**END OF CHECKLIST**

### **3.4 GLIDING**

1. Flaps ..... UP
2. Airspeed ..... 73 KIAS (1150 kg, 2535 lb)  
68 KIAS (1000 kg, 2205 lb)  
60 KIAS (850 kg, 1874 lb)

#### **NOTE**

The glide ratio is 8.8; i.e., for every 1000 ft (305 meters) of altitude loss the maximum horizontal distance traveled in still air is 1.45 NM (2.68 km). During this the propeller will continue to windmill.

With a stationary propeller the glide ratio is 10.3; this corresponds to a maximum horizontal distance of 1.70 NM (3.14 km) for every 1000 ft altitude. In consideration of a safe airspeed however, this configuration may not be attainable.

**END OF CHECKLIST**



### 3.5.2 LANDING WITH A DEFECTIVE TIRE ON THE MAIN LANDING GEAR

#### **CAUTION**

A defective (e.g. burst) tire is not usually easy to detect. The damage normally occurs during take-off or landing, and is hardly noticeable during fast taxiing. It is only during the roll-out after landing or at lower taxiing speeds that a tendency to swerve occurs. Rapid and determined action is then required.

1. Advise ATC.
2. Land the airplane at the edge of the runway that is located on the side of the intact tire, so that changes in direction which must be expected during roll-out due to the braking action of the defective tire can be corrected on the runway.
3. Land with one wing low. The wing on the side of the intact tire should be held low.
4. Direction should be maintained using the rudder. This should be supported by use of the brake. It is possible that the brake must be applied strongly - if necessary to the point where the wheel locks. The wide track of the landing gear will prevent the airplane from tipping over a wide speed range. There is no pronounced tendency to tip even when skidding.

**END OF CHECKLIST**



**3.5.3 LANDING WITH DEFECTIVE BRAKES**

In general, a landing on grass is recommended in order to reduce the landing run due to the greater rolling resistance.

**CAUTION**

If sufficient time is remaining, the risk of fire in the event of a collision can be reduced as follows after a safe touch-down:

- Emergency fuel valve . . . . . OFF
- ENGINE MASTER . . . . . OFF
- ELECTRIC MASTER . . . . . OFF

**END OF CHECKLIST**

### 3.6 RECOVERY FROM AN UNINTENTIONAL SPIN

#### CAUTION

Steps 1 to 4 must be carried out **immediately** and **simultaneously**.

1. Power lever ..... IDLE
2. Rudder ..... full deflection against  
direction of spin
3. Elevator (control stick) ..... fully forward
4. Ailerons ..... neutral
5. Flaps ..... UP

*when rotation has stopped:*

6. Rudder ..... neutral
7. Elevator (control stick) ..... pull carefully
8. Return the airplane from a descending into a normal flight attitude. Do not exceed the 'never exceed speed'  $v_{NE} = 178$  KIAS.

**END OF CHECKLIST**

**3.7 OTHER EMERGENCIES**

**3.7.1 ICING**

Unintentional flight into icing conditions

1. Leave the icing area (by changing altitude or turning back, in order to reach zones with a higher ambient temperature).
2. Pitot heating ..... ON
3. Cabin heat ..... ON
4. Air distributor lever ..... DEFROST
5. Power lever ..... increase power, in order to prevent  
ice build-up on the propeller blades
6. Alternate air ..... OPEN
7. Emergency windows ..... open if required

**CAUTION**

Ice build-up increases the stalling speed.

8. ATC ..... advise if an emergency is expected

**CAUTION**

When the Pitot heating fails:

- Alternate static valve ..... OPEN
- Emergency windows ..... close

**END OF CHECKLIST**

**3.7.2 FAILURES IN THE ELECTRICAL SYSTEM**

(a) Complete failure of the electrical system

1. Circuit breakers . . . . . check if all OK (pressed in)
2. ESSENTIAL BUS . . . . . ON

*if there is still no electrical power available:*

3. EMERGENCY switch . . . . . ON, if installed
4. Flood light, if necessary . . . . . ON
5. Power . . . . . set based on lever positions  
and engine noise
6. Prepare landing with flaps in the given position. Refer to 4B.6 - FAILURES IN FLAP  
OPERATING SYSTEM.
7. Land on the nearest appropriate airfield.

**END OF CHECKLIST**

(b) Starter malfunction

*If the starter does not disengage from the engine after starting (starter warning light (START) on the annunciator panel remains illuminated or blinking after the engine has started):*

1. Power lever . . . . . IDLE
2. ENGINE MASTER . . . . . OFF
3. ELECTRIC MASTER . . . . . OFF

Terminate flight preparation!

**END OF CHECKLIST**

(c) Voltage

*If a voltage in the red range (above 15.5 V or below 11 V) is indicated:*

1. Essential bus ..... ON
2. Land on the nearest appropriate airfield.

**END OF CHECKLIST**

### **3.7.3 SUSPICION OF CARBON MONOXIDE CONTAMINATION IN THE CABIN**

Carbon monoxide (CO) is a gas which is developed during the combustion process. It is poisonous and without smell. Since it occurs however usually together with flue gases, it can be detected. Increased concentration of carbon monoxide in closed spaces can be fatal. The occurrence of CO in the cabin is possible only due to a defect. If a smell similar to exhaust gases is noticed in the cabin, the following measures should be taken:

1. Cabin heat ..... OFF
2. Ventilation ..... open
3. Emergency windows ..... open
4. Airspeed ..... reduce below 120 KIAS
5. Forward canopy ..... unlatch, push up and lock in 'Cooling Gap' position

#### **NOTE**

The maximum demonstrated airspeed for opening the front canopy in flight is 120 KIAS.

#### **CAUTION**

In case of suspicion of carbon monoxide contamination in the cabin, the front canopy may be unlatched during flight. This allows it to partially open, in order to improve ventilation. The canopy will remain open in this position. Flight characteristics will not be affected significantly.

**END OF CHECKLIST**

**3.7.4 'DOOR'-WARNING LIGHT ON**

1. Airspeed ..... reduce
2. Canopy ..... check visually if closed
3. Rear passenger door ..... check visually if closed

**WARNING**

Never unlock the rear passenger door during flight. It may break away.

4. If it is not possible to lock the canopy or the rear passenger door, land on the nearest suitable airfield.

**END OF CHECKLIST**

Intentionally left blank.



## CHAPTER 4A

# NORMAL OPERATING PROCEDURES

	Page
4A.1 INTRODUCTION .....	4A-2
4A.2 AIRSPEEDS FOR NORMAL OPERATING PROCEDURES .....	4A-2
4A.3 CHECKLISTS FOR NORMAL OPERATING PROCEDURES .....	4A-3
4A.3.1 PRE-FLIGHT INSPECTION .....	4A-3
4A.3.2 BEFORE STARTING ENGINE .....	4A-11
4A.3.3 STARTING ENGINE .....	4A-13
4A.3.4 BEFORE TAXIING .....	4A-15
4A.3.5 TAXIING .....	4A-16
4A.3.6 BEFORE TAKE-OFF .....	4A-17
4A.3.7 TAKE-OFF .....	4A-21
4A.3.8 CLIMB .....	4A-22
4A.3.9 CRUISE .....	4A-24
4A.3.10 FUEL TRANSFER .....	4A-25
4A.3.11 DESCENT .....	4A-26
4A.3.12 LANDING APPROACH .....	4A-27
4A.3.13 GO-AROUND .....	4A-28
4A.3.14 AFTER LANDING .....	4A-28
4A.3.15 ENGINE SHUT-DOWN .....	4A-29
4A.3.16 POST-FLIGHT INSPECTION .....	4A-29
4A.3.17 FLIGHT IN RAIN .....	4A-30
4A.3.18 REFUELING .....	4A-30
4A.3.19 FLIGHT AT HIGH ALTITUDE .....	4A-30

## 4A.1 INTRODUCTION

Chapter 4A contains checklists and describes procedures for the normal operation of the airplane.

## 4A.2 AIRSPEEDS FOR NORMAL OPERATING PROCEDURES

Flight mass	850 kg (1874 lb)	1000 kg (2205 lb)	1150 kg (2535 lb)
Airspeed for rotation (Take-off run, $v_R$ ) (Flaps T/O)	49 KIAS	55 KIAS	59 KIAS
Airspeed for take-off climb (best rate-of-climb speed $v_Y$ ) (Flaps T/O)	54 KIAS	60 KIAS	66 KIAS
Airspeed for cruise climb (Flaps UP)	60 KIAS	68 KIAS	73 KIAS
Approach speed for normal landing (Flaps LDG)	58 KIAS	63 KIAS	71 KIAS
Minimum speed during go-around (Flaps T/O)	54 KIAS	60 KIAS	66 KIAS

**4A.3 CHECKLISTS FOR NORMAL OPERATING PROCEDURES**

**4A.3.1 PRE-FLIGHT INSPECTION**

I. Cabin check

- a) MET, NAV, Mass & CG . . . . . flight planning completed
- b) Airplane documents . . . . . complete and up-to-date
- c) ELECTRIC MASTER . . . . . OFF, pull out key
- d) ENGINE MASTER . . . . . check OFF
- e) ECU SWAP . . . . . check AUTOMATIC
- f) Emergency fuel valve . . . . . locked, in NORMAL position
- g) Front canopy & rear door . . . . . clean, undamaged,  
check locking mechanism function
- h) All electrical equipment . . . . . OFF
- i) Circuit breakers . . . . . set in (if one has been pulled, check  
reason)
- j) Power lever . . . . . check condition, freedom of move-  
ment and full travel
- k) Power lever . . . . . IDLE
- l) ELECTRIC MASTER . . . . . ON
- m) Fuel quantity . . . . . check, use alternate mean

**NOTE**

If the Long Range Tank is installed and the fuel quantity indicator reads 15 US gal, the correct fuel quantity must be determined with the fuel quantity measuring device. If this measurement is not carried out, the fuel quantity available for flight planning is 15 US gal.

**CONTINUED**

Doc. # 6.01.05-E	Revision 5      01-Jun-2008	Page 4A - 3
------------------	-----------------------------	-------------

- n) Position lights, strobe lights (ACL) . . . . . check
- o) ELECTRIC MASTER . . . . . OFF
- p) Foreign objects . . . . . check
- q) Controls and trim . . . . . free and correct
- r) Baggage . . . . . stowed and secured

**END OF CHECKLIST**

II. Walk-around check, visual inspection

**CAUTION**

A visual inspection means: examination for damage, cracks, delamination, excessive play, load transmission, correct attachment and general condition. In addition control surfaces should be checked for freedom of movement.

**CAUTION**

In low ambient temperatures the airplane should be completely cleared of ice, snow and similar accumulations.

**CAUTION**

Prior to flight, remove such items as control surfaces gust lock, Pitot cover, tow bar, etc.

**CONTINUED**

Page 4A - 4	Revision 5	01-Jun-2008	Doc. # 6.01.05-E
-------------	------------	-------------	------------------

1. *Left main landing gear:*

- a) Landing gear strut or fairing . . . . . visual inspection
- b) Wheel fairing . . . . . visual inspection
- c) Tire inflation pressure (2.5 bar/36 psi) . . . . . check
- d) Wear, tread depth of tire . . . . . check
- e) Tire, wheel, brake . . . . . visual inspection
- f) Brake line connection . . . . . check for leaks
- g) Slip marks . . . . . visual inspection
- h) Chocks . . . . . remove

2. *Left Wing:*

- a) Entire wing surface . . . . . visual inspection
- b) Step . . . . . visual inspection
- c) Air intake on lower surface . . . . . visual inspection
- d) Openings on lower surface . . . . . check for foreign objects and for traces of fuel (if tank is full, fuel may spill over through the tank vent)
- e) Tank drain . . . . . drain off to check for water and sediment (drain until no water comes out)
- f) Stall warning . . . . . check (suck on opening)
- g) Tank filler . . . . . visual inspection, use alternate mean for fuel qty. check
- h) 2 stall strips on wing . . . . . visual inspection
- i) Pitot probe . . . . . clean, orifices clear
- j) Landing/taxi light . . . . . visual inspection
- k) Wing tip . . . . . visual inspection

**CONTINUED**

- l) Position light, strobe light (ACL) . . . . . visual inspection
- m) Tie-down . . . . . check, clear
- n) Aileron and linkage . . . . . visual inspection
- o) Aileron hinges and safety pin . . . . . visual inspection
- p) Foreign objects in aileron paddle . . . . . visual inspection
- q) Flap and linkage . . . . . visual inspection
- r) Flap hinges and safety pin . . . . . visual inspection
- s) Static dischargers . . . . . visual inspection

**3. Fuselage, left side:**

- a) Canopy, left side . . . . . visual inspection
- b) Rear cabin door & window . . . . . visual inspection
- c) Fuselage skin . . . . . visual inspection
- d) Antennas . . . . . visual inspection
- █ e) Autopilot static source (if installed) . . . . . check for blockage

**4. Empennage:**

- a) Stabilizers and control surfaces . . . . . visual inspection
- b) Hinges . . . . . visual inspection
- c) Elevator trim tab . . . . . visual inspection, check safetying
- d) Rudder trim tab . . . . . visual inspection
- e) Tie-down . . . . . check, clear
- f) Tail skid and lower fin . . . . . visual inspection
- g) Static dischargers . . . . . visual inspection

**CONTINUED**

Page 4A - 6	Revision 5    01-Jun-2008	Doc. # 6.01.05-E
-------------	---------------------------	------------------

5. *Fuselage, right side:*

- a) Fuselage skin . . . . . visual inspection
- b) Rear window . . . . . visual inspection
- c) Canopy, right side . . . . . visual inspection
- d) Autopilot static source (if installed) . . . . . check for blockage

6. *Right wing:*

- a) Flap and linkage . . . . . visual inspection
- b) Flap hinges and safety pin . . . . . visual inspection
- c) Aileron and linkage . . . . . visual inspection
- d) Aileron hinges and safety pin . . . . . visual inspection
- e) Foreign objects in aileron paddle . . . . . visual inspection
- f) Wing tip . . . . . visual inspection
- g) Position light, strobe light (ACL) . . . . . visual inspection
- h) Tie-down . . . . . check, clear
- i) Entire wing surface . . . . . visual inspection
- j) 2 stall strips on wing . . . . . visual inspection
- k) Tank filler . . . . . visual check, use alternate mean  
for fuel qty. check
- l) Openings on lower surface . . . . . check for foreign objects and for  
traces of fuel (if tank is full, fuel may  
spill over through the tank vent)
- m) Tank drain . . . . . drain off to check for water and  
sediment (drain until no water  
comes out)

**CONTINUED**

- || n) Fuel cooler baffle on stub wing . . . . . check
  - || removed, if OAT on ground is higher than 20 °C (68 °F)
  - || installed, if OAT on ground is lower than 20 °C (68 °F)
- o) Step . . . . . visual inspection
- p) Static dischargers . . . . . visual inspection

7. *Right Main Landing Gear:*

- a) Landing gear strut or fairing . . . . . visual inspection
- b) Wheel fairing . . . . . visual inspection
- c) Tire inflation pressure (2.5 bar/36 psi) . . . . . check
- d) Wear, tread depth of tires . . . . . check
- e) Tire, wheel, brake . . . . . visual inspection
- f) Brake line connection . . . . . check for leaks
- g) Slip marks . . . . . visual inspection
- h) Chocks . . . . . remove

8. *Front fuselage:*

- a) Engine oil level . . . . . check dipstick (inspection hole in the upper cowling)
- b) Gearbox oil level . . . . . check visually (inspection hole in the lower cowling)
- c) Cowling . . . . . visual inspection
- d) 5 air intakes . . . . . clear
- e) Propeller . . . . . visual inspection

**CONTINUED**

Page 4A - 8	Revision 5    01-Jun-2008	Doc. # 6.01.05-E
-------------	---------------------------	------------------



**WARNING**

Never move the propeller by hand while the ENGINE MASTER switch is ON! Also do not move the propeller by hand while the ENGINE MASTER is OFF immediately after operation (remaining pressure in the rail). Serious personal injury may result.

- f) Spinner including attachment screws . . . . . visual inspection
- █ g) Nose landing gear strut . . . . . visual inspection
- █ h) Gear strut fairing (if installed) . . . . . visual inspection
- █ i) Winter Baffle (if installed) . . . . . visual inspection
- █ j) Tie-down (if installed) . . . . . check, clear
- k) Tire and wheel . . . . . visual inspection,  
check slip marks
- l) Wear, tread depth of tire . . . . . check
- m) Wheel fairing . . . . . visual inspection
- n) Tow bar . . . . . removed
- o) Tire inflation pressure (2.0 bar/29 psi) . . . . . check
- p) Chocks . . . . . remove
- q) Exhaust . . . . . visual inspection

**WARNING**

The exhaust can cause burns when it is hot.

**CONTINUED**

*Underside:*

- r) Antennas (if fitted) ..... visual inspection
- s) Gascolator ..... drain off to check for water and sediment (drain until no water comes out)
- t) Venting pipes ..... check for blockage
- u) Fuselage underside ..... check for excessive contamination particularly by oil, fuel, and other fluids

**END OF CHECKLIST**

**4A.3.2 BEFORE STARTING ENGINE**

- 1. Pre-flight inspection . . . . . complete
- 2. Rudder pedals . . . . . adjusted and locked
- 3. Passengers . . . . . instructed
- 4. Safety harnesses . . . . . all on and fastened
- 5. Rear door . . . . . closed and locked
- 6. Front canopy . . . . . Position 1 or 2 (“cooling gap”)

**CAUTION**

When operating the canopy, pilots / operators are to ensure that there are no obstructions between the canopy and the mating frame, for example seat belts, clothing, etc. When operating the locking handle do NOT apply undue force.

**NOTE**

A slight downward pressure on the canopy may be required to ease the handle operation.

- 7. Parking brake . . . . . set
- 8. Flight controls . . . . . free movement
- 9. Trim wheel . . . . . T/O
- 10. Power lever . . . . . check IDLE
- 11. Friction device on power lever . . . . . adjusted
- 12. Alternate air . . . . . check CLOSED
- 13. Alternate static valve . . . . . check CLOSED
- 14. AVIONIC MASTER . . . . . check OFF
- 15. ELECTRIC MASTER . . . . . ON
- 16. Annunciator panel / engine instruments . . . . . check
- 17. Acknowledge button . . . . . press

**CONTINUED**

- 18. WATER LEVEL caution light ..... check OFF
- 19. Fuel temperature ..... check

**WARNING**

Never move the propeller by hand.

**WARNING**

If Diesel Fuel or a blend of Diesel Fuel with JET Fuel is used, or if the fuel grade is unknown, the engine must not be started if the fuel temperature indication on the left side prior to operation is flashing (below -5 °C/ +23 °F) on a conventional instrument panel, or is below -5 °C (+23 °F) on a G1000 instrument panel.

Operation with a flashing fuel temperature indication on a conventional instrument panel (below -5 °C/ +23 °F) or below -5 °C (+23 °F) on a G1000 instrument panel is not permitted, as safe operation of the engine under those conditions cannot be ensured and the engine can stop.

**NOTE**

Make sure which fuel grade is being used (see Section 7.9.5). If it is not possible to determine the fuel grade, the Diesel Fuel temperature limitations must be observed.

**END OF CHECKLIST**

Page 4A - 12	Revision 5    01-Jun-2008	Doc. # 6.01.05-E
--------------	---------------------------	------------------

**4A.3.3 STARTING ENGINE**

- 1. Strobe light (ACL) ..... ON
- 2. Power lever ..... check IDLE
- 3. ENGINE MASTER ..... ON, wait until GLOW indication  
extinguishes

**WARNING**

Before starting the engine the pilot must ensure that the propeller area is free, and no persons can be endangered.

**CAUTION**

Do not overheat the starter motor. Do not operate the starter motor for more than 10 seconds. After operating the starter motor, let it cool off for 20 seconds. After 6 attempts to start the engine, let the starter cool off for half an hour.

- 4. ELECTRIC MASTER ..... START
- 5. Oil pressure ..... check

**WARNING**

If the oil pressure has not moved from the red range within 3 seconds after starting, set the ENGINE MASTER switch to OFF and investigate problem. When starting the cold engine, the oil pressure can be as high as 6.5 bar for a maximum of 20 seconds.

**CONTINUED**

- 6. Warm up ..... IDLE for 2 minutes
- 7. Warm up ..... 1400 RPM until oil temperature  
and coolant temperature are in the  
green range
- 8. Annunciator panel / engine instruments ..... check
- 9. Acknowledge button ..... press

**END OF CHECKLIST**

**4A.3.4 BEFORE TAXIING**

- 1. AVIONIC MASTER ..... ON
- 2. Electrical equipment ..... ON as required
- 3. Flaps ..... UP - T/O - LDG - T/O  
(indicator and visual check)
- 4. Flight instruments and avionics ..... set, test function, as required
- 5. Flood light ..... ON, test function, as required
- 6. Pitot heating ..... ON, test function
- 7. Pitot heating ..... OFF
- 8. Strobe lights (ACLs) ..... check ON
- 9. Position lights, landing and taxi lights ..... ON, test function, as required

**CAUTION**

When taxiing at close range to other aircraft, or during night flight in clouds, fog or haze, the strobe lights should be switched OFF. The position lights must always be switched ON during night flight.

- 10. Idle RPM ..... check, 890 ±20 RPM

**END OF CHECKLIST**

**4A.3.5 TAXIING**

1. Parking brake . . . . . release
2. Brakes . . . . . test on moving off
3. Flight instrumentation and avionics  
(particularly directional gyro and  
turn and bank indicator) . . . . . check for correct indications

**CAUTION**

When taxiing on a poor surface select the lowest possible RPM to avoid damage to the propeller from stones or similar items.

**END OF CHECKLIST**



**4A.3.6 BEFORE TAKE-OFF**

1. Position airplane into wind if possible.
2. Parking brake . . . . . set
3. Safety harnesses . . . . . on and fastened
4. Rear door . . . . . check closed and locked
5. Front canopy . . . . . closed and locked

**CAUTION**

When operating the canopy, pilots / operators are to ensure that there are no obstructions between the canopy and the mating frame, for example seat belts, clothing, etc. When operating the locking handle do NOT apply undue force.

A slight downward pressure on the canopy may be required to ease the handle operation.

6. Door warning light (DOOR) . . . . . check no indication
7. Engine instruments . . . . . check in green range (except oil pressure may be in yellow range with a warm engine and power lever at IDLE, and fuel temp may be in the low yellow range if the airplane is operated with JET Fuel)

**CONTINUED**

**WARNING**

If the airplane is operated with Diesel Fuel or a blend of Diesel Fuel with JET Fuel, or the fuel grade is unknown, the fuel temperature on the left side must be in the green range (minimum +5 °C / +41 °F) before take-off.

**CAUTION**

If the airplane is operated with Diesel Fuel or a blend of Diesel Fuel with JET Fuel, or the fuel grade is unknown, a safe fuel transfer is not ensured until the fuel temperature indication of both fuel tanks is in the green range (minimum +5 °C / +41 °F).

- 8. Circuit breakers . . . . . check pressed in
- 9. Flaps . . . . . check T/O
- 10. Trim . . . . . check T/O
- 11. Flight controls . . . . . free movement, correct sense
- 12. Power lever . . . . . MAX for 10 seconds
- 13. Oil pressure . . . . . check green range
- 14. RPM . . . . . stabilizes at 2240 to 2300 RPM
- 15. LOAD indication . . . . . stabilizes at 90 to 100 %

**NOTE**

Under high temperature and high altitude conditions, load indications below 90 % are possible.

**CONTINUED**

- 16. Power lever ..... IDLE
- 17. ECU TEST ..... press and hold
- 18. Caution lights (ECU A, ECU B, CAUTION) .. blinking
- 19. 'ECU BACKUP UNSAFE'-light ..... blinking, if installed

**WARNING**

| If the caution lights and the 'ECU BACKUP UNSAFE'-light  
 | do not illuminate, there is an error in the test procedure.  
 | IFR-flights are prohibited.

- 20. Caution lights (ECU B, CAUTION) ..... blinking
- 21. Propeller RPM ..... cycling
- 22. Caution lights (ECU A, CAUTION) ..... blinking
- 23. Propeller RPM ..... cycling
- 24. Caution lights ..... extinguished
- 25. 'ECU BACKUP UNSAFE'-light ..... extinguished

**WARNING**

| If the 'ECU BACKUP UNSAFE'-light does not extinguish after  
 | the test, the ECU Backup Battery System does not have  
 | sufficient power to supply the engine with electrical power in  
 | case of a severe electric malfunction. IFR-flights are  
 | prohibited.

When switching from one ECU to the other a slight shake of  
 the engine may occur. In case of longer dropouts of the  
 engine, or if the engine stops during the test, terminate flight  
 preparation.

**CONTINUED**

26. ECU TEST ..... release

**CAUTION**

The whole test procedure must be passed without any error.  
In case of an error terminate flight preparation even when the engine seems to run smoothly after the test procedure.

27. ECU SWAP ..... ECU B

28. Engine ..... check running without a change

29. ECU SWAP ..... AUTOMATIC

**NOTE**

When switching from one ECU to the other a slight shake of the engine may occur.

30. Pitot heating ..... ON, if required

31. Landing light ..... ON, if required

32. Parking brake ..... release

**END OF CHECKLIST**



**4A.3.7 TAKE-OFF**

Normal take-off procedure

1. Transponder . . . . . ON/ALT
2. Power lever . . . . . MAX

**WARNING**

The proper performance of the engine at MAX should be checked early in the take-off procedure, so that the take-off can be aborted if necessary.

3. Elevator . . . . . neutral
4. Rudder . . . . . maintain direction

**NOTE**

In strong crosswinds steering can be augmented by use of the toe brakes. It should be noted, however, that this method increases the take-off roll, and should not generally be used.

5. Nose wheel lift-off . . . . .  
at  $v_R = 59$  KIAS (1150 kg, 2535 lb)  
at  $v_R = 55$  KIAS (1000 kg, 2205 lb)  
at  $v_R = 49$  KIAS (850 kg, 1874 lb)
6. Airspeed for initial climb . . . . . 66 KIAS

*above a safe height:*

7. Landing light . . . . . OFF

**END OF CHECKLIST**

Doc. # 6.01.05-E	Revision 5      01-Jun-2008	Page 4A - 21
------------------	-----------------------------	--------------

**4A.3.8 CLIMB**

Procedure for best rate of climb

1. Flaps ..... T/O
2. Airspeed ..... 66 KIAS (1150 kg, 2535 lb)

**NOTE**

With lower mass the air speeds can be reduced as given below:

1000 kg / 2205 lb ..... 60 KIAS

850 kg / 1874 lb ..... 54 KIAS

The engine temperatures must be observed then.

3. Power lever ..... MAX
4. Engine instruments ..... in green range
5. Trim ..... as required

**CAUTION**

If the oil temperature and/or coolant temperature reaches the yellow range during climb, flight should be continued with an airspeed increased by 5 kts and power reduced by 10 % (reduced climb rate) for better engine cooling.

**END OF CHECKLIST**

Cruise climb

- 1. Flaps ..... UP
- 2. Airspeed ..... 73 KIAS (1150 kg, 2535 lb)

**NOTE**

With lower mass the air speeds can be reduced as given below:

1000 kg / 2205 lb ..... 68 KIAS

850 kg / 1874 lb ..... 60 KIAS

The engine temperatures must be observed then.

- 3. Power lever ..... MAX
- 4. Engine instruments ..... in green range
- 5. Trim ..... as required

**END OF CHECKLIST**

**4A.3.9 CRUISE**

1. Flaps ..... UP
2. Power lever ..... performance as required
3. Trim ..... as required
4. Fuel transfer ..... repeat as required (in accordance with 4A.3.10 - FUEL TRANSFER)

**NOTE**

The engine manufacturer recommends a cruise power setting of 70 %.

**NOTE**

Proper operation of the transfer pump must be checked by monitoring the fuel quantities (increasing in the MAIN tank, decreasing in the AUX tank).

**END OF CHECKLIST**



**4A.3.10 FUEL TRANSFER**
**CAUTION**

During normal operation fuel is taken from the main tank only. Therefore fuel must be transferred from the auxiliary tank to the main tank by activating the fuel transfer pump. The transfer rate is approximately 60 US gal/h (227 liters/h).

1. Fuel transfer switch ..... ON

**NOTE**

The transfer pump turns off automatically to avoid overfilling the main tank. The switch remains in its position. If the pump is not turned off, it will continue pumping each time the fuel level in the main tank drops, but only as long as there is fuel in the auxiliary tank. The fuel transfer status light is illuminated only while the pump is running.

2. Fuel transfer switch ..... OFF, if required

**NOTE**

If the fuel transfer status light starts to blink, the fuel transfer pump must be switched off.

**END OF CHECKLIST**

**4A.3.11 DESCENT**

- 1. Power lever ..... as required (below 5000 ft)  
above 5000 ft not less than 30%

**CAUTION**

Engine combustion may stop unrecognized during descents with idle power at altitudes above 5000 ft with outside air temperatures below -10 °C.

- 2. Power lever ..... clear engine occasionally

Restart Procedure see Chapter 3.2.3 - ENGINE PROBLEMS IN FLIGHT.

**END OF CHECKLIST**

**4A.3.12 LANDING APPROACH**

- 1. Safety harnesses ..... check fastened & tightened
- 2. Airspeed ..... reduce to operate flaps (108 KIAS)
- 3. Flaps ..... T/O
- 4. Trim ..... as required
- 5. Landing light ..... as required

*before landing:*

- 6. Power lever ..... as required
- 7. Airspeed ..... reduce to operate flaps (91 KIAS)
- 8. Flaps ..... LDG
- 9. Approach speed ..... 71 KIAS (1150 kg, 2535 lb)  
67 KIAS (1092 kg, 2407 lb)  
63 KIAS (1000 kg, 2205 lb)  
58 KIAS (850 kg, 1874 lb)

**NOTE**

In case of airplanes with a maximum landing mass of 1092 kg (2407 lb), a landing with a higher mass constitutes an abnormal operating procedure. Refer to Sections 2.7 and 4B.7.

**NOTE**

Higher approach speeds result in a significant longer landing distance during flare.

**CAUTION**

In conditions such as (e.g.) strong wind, danger of wind shear or turbulence a higher approach speed should be selected.

**END OF CHECKLIST**

Doc. # 6.01.05-E	Revision 5	01-Jun-2008	Page 4A - 27
------------------	------------	-------------	--------------

**4A.3.13 GO-AROUND**

1. Power lever ..... MAX
2. Airspeed ..... 66 KIAS (1150 kg, 2535 lb)  
60 KIAS (1000 kg, 2205 lb)  
54 KIAS (850 kg, 1874 lb)
3. Flaps ..... T/O

*above a safe height:*

4. Airspeed ..... 73 KIAS
5. Flaps ..... UP

**END OF CHECKLIST**

**4A.3.14 AFTER LANDING**

1. Power lever ..... IDLE
2. Brakes ..... as required
3. Transponder ..... OFF / STBY
4. Pitot heating ..... OFF
5. Avionics ..... as required
6. Lights ..... as required
7. Flaps ..... UP

**END OF CHECKLIST**

#### **4A.3.15 ENGINE SHUT-DOWN**

1. Parking brake . . . . . set
2. Power lever . . . . . IDLE for 2 minutes
3. Engine instruments . . . . . check
4. AVIONIC MASTER . . . . . OFF
5. Electrical consumers . . . . . OFF
6. ENGINE MASTER . . . . . OFF
7. ELECTRIC MASTER . . . . . OFF

### **CAUTION**

Before shut-down the engine must run for at least 2 minutes with the power lever at IDLE to avoid heat damage of the turbo charger.

#### **END OF CHECKLIST**

#### **4A.3.16 POST-FLIGHT INSPECTION**

1. ENGINE MASTER . . . . . OFF
2. ELECTRIC MASTER . . . . . ON
3. AVIONIC MASTER . . . . . ON
4. ELT . . . . . check activated:  
listen on 121.5 MHz
5. AVIONIC MASTER . . . . . OFF
6. ELECTRIC MASTER . . . . . OFF
7. Parking brake . . . . . release, use chocks
8. Airplane . . . . . moor, if unsupervised for extended period

#### **END OF CHECKLIST**

#### 4A.3.17 FLIGHT IN RAIN

##### **NOTE**

Performance deteriorates in rain; this applies particularly to the take-off distance and to the maximum horizontal speed. The effect on the flight characteristics is minimal. Flight through very heavy rain should be avoided because of the associated visibility problems.

#### 4A.3.18 REFUELING

##### **CAUTION**

Before refueling, the airplane must be connected to electrical ground. Grounding points: unpainted areas on steps, left and right.

##### **NOTE**

If the airplane is operated with Diesel Fuel, additional temperature limitations must be observed.

If JET Fuel is used make sure that no Diesel Fuel is remaining in the tanks, neither in the left nor in the right tank (see fuel grade, Section 7.9.5). Otherwise the temperature limitations for Diesel operation must be observed.

#### 4A.3.19 FLIGHT AT HIGH ALTITUDE

At high altitudes the provision of oxygen for the occupants is necessary. Legal requirements for the provision of oxygen should be adhered to.

Also see Section 2.11 - OPERATING ALTITUDE.

## CHAPTER 4B

# ABNORMAL OPERATING PROCEDURES

	Page
4B.1 PRECAUTIONARY LANDING .....	4B-2
4B.2 INSTRUMENT INDICATIONS OUTSIDE OF GREEN RANGE ...	4B-4
4B.2.1 RPM .....	4B-4
4B.2.2 COOLANT TEMPERATURE CT .....	4B-5
4B.2.3 OIL TEMPERATURE OT .....	4B-7
4B.2.4 OIL PRESSURE OP .....	4B-8
4B.2.5 GEARBOX TEMPERATURE GT .....	4B-9
4B.2.6 FUEL TEMPERATURE FUEL TEMP .....	4B-9
4B.3 FAILURES IN THE ELECTRICAL SYSTEM INDICATED ON THE ANNUNCIATOR PANEL .....	4B-10
4B.3.1 LOW VOLTAGE CAUTION (LOW VOLTS) .....	4B-10
4B.3.2 ECU A FAILURE (ECU A) .....	4B-11
4B.3.3 ECU B FAILURE (ECU B) .....	4B-12
4B.3.4 ALTERNATOR FAILURE (ALTERNATOR) .....	4B-13
4B.3.5 ENGINE FAILURE (ENGINE) .....	4B-14
4B.3.6 PITOT HEATING FAILURE (PITOT) .....	4B-15
4B.3.7 LOW FUEL CAUTION (LOW FUEL) .....	4B-16
4B.4 FAILURES IN THE ELECTRICAL SYSTEM INDICATED ON THE AUXILIARY ENGINE DISPLAY (AED 125) .....	4B-17
4B.4.1 HIGH ELECTRIC LOAD CAUTION (GENERATOR) ...	4B-17
4B.4.2 VOLT .....	4B-18
4B.5 TAKE-OFF FROM A SHORT GRASS STRIP .....	4B-19
4B.6 FAILURES IN FLAP OPERATING SYSTEM .....	4B-20
4B.7 LANDING WITH HIGH LANDING MASS .....	4B-21

## 4B.1 PRECAUTIONARY LANDING

### NOTE

A landing of this type is only necessary when there is a reasonable suspicion that due to fuel shortage, weather conditions, or at nightfall the possibility of endangering the airplane and its occupants by continuing the flight cannot be excluded. The pilot is required to decide whether or not a controlled landing in a field represents a lower risk than the attempt to reach the target airfield under all circumstances.

### NOTE

If no level landing area is available, a landing on an upward slope should be sought.

1. Select appropriate landing area.
2. Consider wind.
3. Approach: If possible, the landing area should be overflown at a suitable height in order to recognize obstacles. The degree of offset at each part of the circuit will allow the wind speed and direction to be assessed.
4. Airspeed ..... 73 KIAS (1150 kg, 2535 lb)  
68 KIAS (1000 kg, 2205 lb)  
60 KIAS (850 kg, 1874 lb)
5. ATC ..... advise

**CONTINUED**

Page 4B - 2	Revision 5    01-Jun-2008	Doc. # 6.01.05-E
-------------	---------------------------	------------------



*on final approach:*

- 6. Flaps ..... LDG
- 7. Approach speed ..... 67 KIAS (1092 kg, 2407 lb)  
63 KIAS (1000 kg, 2205 lb)  
58 KIAS (850 kg, 1874 lb)
- 8. Safety harnesses ..... tighten
- 9. Touchdown ..... with the lowest possible airspeed

**CAUTION**

If sufficient time is remaining, the risk of fire in the event of a collision with obstacles can be reduced as follows after a safe touch-down:

- Emergency fuel valve ..... OFF
- ENGINE MASTER ..... OFF
- ELECTRIC MASTER ..... OFF

**END OF CHECKLIST**

## **4B.2 INSTRUMENT INDICATIONS OUTSIDE OF GREEN RANGE**

### **4B.2.1 RPM**

#### High RPM

1. Reduce power.
2. Keep RPM within the green range using the power lever.

#### **NOTE**

An RPM in the yellow range is permissible for a short time if required, e.g. for go-around.

#### **CAUTION**

If the available power is too low to continue a safe flight, perform a precautionary landing on the nearest airfield in accordance with 4B.1 - PRECAUTIONARY LANDING.

**END OF CHECKLIST**

**4B.2.2 COOLANT TEMPERATURE CT**High coolant temperature

- Check coolant qty. caution light (WATER LEVEL).

*if off:*

*during climb:*

- Reduce power by 10 %.
- Increase airspeed by 10 KIAS.
- If the coolant temperature does not reach the green range within 60 seconds, reduce power as far as possible and increase airspeed.

*during cruise:*

- Reduce power.
- Increase airspeed.
- Check coolant temperature in green range.

**CAUTION**

If the coolant temperature does not return to the green range, perform a precautionary landing on the nearest airfield in accordance with 4B.1 - PRECAUTIONARY LANDING.

*if on:*

- Reduce power.
- Expect loss of coolant.

**CONTINUED**

**WARNING**

A further increase in coolant temperature must be expected.  
Prepare for an emergency landing in accordance with  
3.5.1 - EMERGENCY LANDING WITH ENGINE OFF.

**END OF CHECKLIST**

Low coolant temperature

- Check coolant qty. caution light (WATER LEVEL).

**NOTE**

During an extended descent from high altitudes with a low  
power setting coolant temperature may decrease.

*if on:*

- Reduce power.
- Expect loss of coolant.

**WARNING**

A further decrease in coolant temperature must be expected.  
Prepare for an emergency landing in accordance with  
3.5.1 - EMERGENCY LANDING WITH ENGINE OFF.

**END OF CHECKLIST**

**4B.2.3 OIL TEMPERATURE OT**High oil temperature

- Check oil pressure.

*if the oil pressure is low:*

- Reduce power.
- Expect loss of oil with engine failure. Prepare for an emergency landing in accordance with 3.5.1 - EMERGENCY LANDING WITH ENGINE OFF.

*if the oil pressure is within the green range:*

- Reduce power.
- Increase airspeed.
- █ - monitor oil temperature (OT).

**END OF CHECKLIST**

Low oil temperature

- Increase power.
- Reduce airspeed.
- █ - monitor oil temperature (OT).

**END OF CHECKLIST**

#### 4B.2.4 OIL PRESSURE OP

##### High oil pressure

- Check oil temperature.
- Check coolant temperature.

*if the temperatures are within the green range:*

- Expect wrong oil pressure indication. Keep monitoring temperatures.

*if the temperatures are not within the green range:*

- Reduce power.
- Expect engine failure. Prepare for an emergency landing in accordance with 3.5.1 - EMERGENCY LANDING WITH ENGINE OFF.

#### **CAUTION**

When starting a cold engine, the oil pressure can be as high as 6.5 bar for a maximum of 20 seconds.

#### **END OF CHECKLIST**

##### Low oil pressure

#### **NOTE**

If the RPM indication is less than 1500 RPM with the power lever at IDLE, the oil pressure must drop into the red range to cause the caution light to illuminate.

- Reduce power.
- monitor oil temperature (OT).
- Expect loss of oil with engine failure. Prepare for an emergency landing in accordance with 3.5.1 - EMERGENCY LANDING WITH ENGINE OFF.

#### **END OF CHECKLIST**

**4B.2.5 GEARBOX TEMPERATURE GT**High gearbox temperature

- Reduce power.
- Increase airspeed.

**END OF CHECKLIST****4B.2.6 FUEL TEMPERATURE FUEL TEMP**High fuel temperature

- Reduce power.
- Increase airspeed.

**NOTE**

Increased fuel temperature can occur when the fuel quantity in the main tank is low. The fuel temperature can be decreased by transferring fuel from the auxiliary to the main tank.

**END OF CHECKLIST**Low fuel temperature

- Increase power.
- Reduce airspeed.

*If the fuel cooler is in operation (baffle removed):*

- select lower flight altitude, if possible.

**END OF CHECKLIST**

## **4B.3 FAILURES IN THE ELECTRICAL SYSTEM INDICATED ON THE ANNUNCIATOR PANEL**

### **4B.3.1 LOW VOLTAGE CAUTION (LOW VOLTS)**

This caution is indicated when the normal on-board voltage (14 V) drops below 12.6 V.

Possible reasons are:

- A fault in the power supply.
- RPM too low.

#### **(a) 'Low Voltage' caution on the ground**

1. Circuit breakers . . . . . check
2. Power lever . . . . . increase RPM
3. If the caution light does not go out . . . . . terminate flight preparation

#### **(b) 'Low Voltage' caution during flight**

1. Circuit breakers . . . . . check
2. Electrical equipment . . . . . OFF if not needed
3. If the caution light does not go out . . . . . Follow procedure in 4B.3.4 -  
ALTERNATOR FAILURE

#### **(c) 'Low Voltage' caution during landing**

- Follow (a) after landing.

**END OF CHECKLIST**

Page 4B - 10	Revision 5    01-Jun-2008	Doc. # 6.01.05-E
--------------	---------------------------	------------------



**4B.3.2 ECU A FAILURE (ECU A)****(a) 'ECU A' caution on the ground**

- Terminate flight preparation.

**(b) 'ECU A' caution during flight****NOTE**

In case of a failure in the electronic ECU (Engine Control Unit) 'A' the system automatically switches to ECU 'B'.

1. Press the ECU TEST button for more than 2 seconds to reset the caution message.

*If the ECU A caution re-appears or cannot be reset:*

2. Land on nearest suitable airfield.
3. The engine must be serviced after landing.

*If the ECU A caution can be reset:*

2. Continue flight.
3. The engine must be serviced after landing.

**END OF CHECKLIST**

### **4B.3.3 ECU B FAILURE (ECU B)**

#### **(a) 'ECU B' caution on the ground**

- Terminate flight preparation.

#### **(b) 'ECU B' caution during flight**

- 1. Press the ECU TEST button for more than 2 seconds to reset the caution message.

*If the ECU B caution re-appears, or cannot be reset:*

- 2. Land on nearest suitable airfield.
- 3. The engine must be serviced after landing.

*If the ECU B caution can be reset:*

- 2. Continue flight.
- 3. The engine must be serviced after landing.

**END OF CHECKLIST**

#### **4B.3.4 ALTERNATOR FAILURE (ALTERNATOR)**

An alternator failure is indicated by an illuminated or blinking alternator caution light (ALTERNATOR) on the annunciator panel. The batteries are the last remaining source of electrical power for a minimum of 30 minutes.

1. Circuit breakers ..... check; if all are O.K., proceed with step 2
2. ESSENTIAL BUS ..... ON
3. Electrical equipment ..... switch OFF all equipment which is not needed
4. Land on the nearest suitable airfield

#### **WARNING**

The ECU, which is absolutely necessary for engine operation, needs electrical power. It is recommended to switch off all electrical consumers and to land as soon as possible. Be prepared for an engine failure and an emergency landing. For a severe electrical failure a ECU-Backup-System is installed.

#### **CAUTION**

For cases, in which the battery capacity is not sufficient to reach a suitable airfield, an emergency battery is installed in the IFR model, serving as an additional back-up system for the attitude gyro (artificial horizon) and flood light. This battery is switched on with the Emergency Switch, located on the left side of the instrument panel.

#### **END OF CHECKLIST**

Doc. # 6.01.05-E	Revision 5    01-Jun-2008	Page 4B - 13
------------------	---------------------------	--------------

**4B.3.5 ENGINE FAILURE (ENGINE)**

1. Engine instrument CED 125 ..... check
2. Engine instrument AED 125 ..... check
3. Acknowledge button ..... press

**NOTE**

If an indication either on the CED 125 or AED 125 is near the end of the green range, it may happen that it switches over to the yellow or red range for a short time. This will also cause the ENGINE caution light to illuminate.

**NOTE**

If an indication either on the CED 125 or AED 125 is outside of the green range, proceed in accordance with 4B.2 - INSTRUMENT INDICATIONS OUTSIDE OF THE GREEN RANGE.

**END OF CHECKLIST**

**4B.3.6 PITOT HEATING FAILURE (PITOT)**

- 1. Pitot heating . . . . . check ON

**NOTE**

The Pitot heating caution message is displayed when the Pitot heating is switched off, or when there is a failure of the Pitot heating system. Prolonged operation of the Pitot heating on the ground can also cause the Pitot heating caution message to be displayed. In this case it indicates the activation of the thermal switch, which prevents overheating of the Pitot heating system on the ground. This is a normal function of the system. After a cooling period, the heating system will be switched on again automatically.

*if in icing conditions:*

- 2. Expect loss of static instruments.
- 3. Alternate Static . . . . . OPEN
- 4. Leave icing zone.

**END OF CHECKLIST**

**4B.3.7 LOW FUEL CAUTION (LOW FUEL)**

1. Fuel transfer pump . . . . . ON
2. Fuel quantity . . . . . check

**CAUTION**

As soon as the amount of usable fuel in the main tank is less than 3 US gal (+2/-1 US gal), a caution message is displayed. The indication is calibrated for straight and level flight. The caution message may be triggered during turns which are flown with slip, or while taxiing in curves.

*if the caution light does not extinguish:*

- Expect loss of fuel.
- Be prepared for an emergency landing.
- Proceed in accordance with 3.5.1 - EMERGENCY LANDING WITH ENGINE OFF.

**WARNING**

When the fuel pump takes in air (e.g. when the emergency fuel valve is not switched back and the auxiliary tank is empty), an inspection of the pump is necessary prior to next flight.

**END OF CHECKLIST**

**4B.4 FAILURES IN THE ELECTRICAL SYSTEM INDICATED ON  
THE AUXILIARY ENGINE DISPLAY (AED 125)**

**4B.4.1 HIGH ELECTRIC LOAD CAUTION (GENERATOR)**

This caution is indicated when the consumption of electrical power is too high.

Possible reasons are:

- A fault in wiring or equipment

1. Electrical equipment . . . . . switch OFF as necessary and possible to reduce electric load

*if the problem does not clear itself:*

2. Land on the nearest suitable airfield.

**END OF CHECKLIST**

**4B.4.2 VOLT**

Low voltage

1. Circuit breakers . . . . . check
2. Electrical equipment . . . . . OFF if not needed

*if 'Low voltage' is still indicated on the AED 125:*

3. Follow procedure in 4B.3.4 - ALTERNATOR FAILURE (ALTERNATOR)

**END OF CHECKLIST**

High voltage

- Land on the nearest suitable airfield.

**NOTE**



The ENGINE caution light on a conventional instrument panel can illuminate during warm-up on the ground due to the increased voltage indication in case of a cold engine (see voltmeter, Section 7.10).

**END OF CHECKLIST**



**4B.5 TAKE-OFF FROM A SHORT GRASS STRIP**

1. Brakes ..... apply
2. Flaps ..... T/O
3. Power lever ..... MAX
4. Elevator (control stick) ..... fully aft
5. Brakes ..... release
6. Hold direction ..... using rudder

**NOTE**

In strong crosswinds steering can be augmented by use of the toe brakes. It should be noted, however, that this method increases the take-off roll, and should not generally be used.

7. Elevator (control stick) ..... Release slowly after nose wheel has lifted.  
Allow airplane to lift off as soon as possible and increase speed at low level.
8. Airspeed ..... 66 KIAS (1150 kg, 2535 lb)  
60 KIAS (1000 kg, 2205 lb)  
54 KIAS (850 kg, 1874 lb)
9. Flaps ..... UP, above safe altitude
10. Airspeed ..... 73 KIAS (1150 kg, 2535 lb)  
68 KIAS (1000 kg, 2205 lb)  
60 KIAS (850 kg, 1874 lb)
11. Landing light ..... as required

**END OF CHECKLIST**

Doc. # 6.01.05-E	Revision 5    01-Jun-2008	Page 4B - 19
------------------	---------------------------	--------------

## **4B.6 FAILURES IN FLAP OPERATING SYSTEM**

### Failure in position indication or function

- Check flap position visually.
- Keep airspeed in white sector.
- Re-check all positions of the flap switch.

### Modified approach procedure depending on the available flap setting

#### *(a) Only UP available:*

Airspeed ..... 73 KIAS (1150 kg, 2535 lb)  
68 KIAS (1000 kg, 2205 lb)  
60 KIAS (850 kg, 1874 lb)

Land at a flat approach angle, use power lever to control airplane speed and rate of descent.

#### *(b) Only T/O available:*

Airspeed ..... 73 KIAS (1150 kg, 2535 lb)  
68 KIAS (1000 kg, 2205 lb)  
60 KIAS (850 kg, 1874 lb)

Land at a flat approach angle, use power lever to control airplane speed and rate of descent.

#### *(c) Only LDG available:*

Perform normal landing.

## **END OF CHECKLIST**

Page 4B - 20	Revision 5    01-Jun-2008	Doc. # 6.01.05-E
--------------	---------------------------	------------------

**4B.7 LANDING WITH HIGH LANDING MASS**

**NOTE**

This Section only applies to airplanes with a maximum landing mass of 1092 kg (2407 lb). In case of airplanes with a maximum landing mass of 1150 kg (2535 lb) a landing with a mass between 1092 kg and 1150 kg (2407 and 2535 lb) constitutes a normal operating procedure. Refer to Sections 2.7 and 4A.3.12.

**NOTE**

The maximum landing mass given in Chapter 2 is the highest mass for landing conditions at the maximum descent velocity. This velocity was used in the strength calculations to determine the landing gear loads during a particularly hard landing.

Perform landing approach and landing according to Chapter 4A, but maintain an increased airspeed during landing approach.

Approach speed ..... 71 KIAS (1150 kg, 2535 lb)

**WARNING**

Damage of the landing gear can result from a hard landing with a flight mass above the maximum landing mass.

**END OF CHECKLIST**

Doc. # 6.01.05-E	Revision 5    01-Jun-2008	Page 4B - 21
------------------	---------------------------	--------------

Intentionally left blank.

## CHAPTER 5

# PERFORMANCE

	Page
5.1 INTRODUCTION .....	5-2
5.2 USE OF THE PERFORMANCE TABLES AND DIAGRAMS .....	5-2
5.3 PERFORMANCE TABLES AND DIAGRAMS .....	5-3
5.3.1 AIRSPEED CALIBRATION .....	5-3
5.3.2 DIAGRAM FOR SETTING ENGINE PERFORMANCE .....	5-4
5.3.3 PRESSURE ALTITUDE - DENSITY ALTITUDE .....	5-5
5.3.4 INTERNATIONAL STANDARD ATMOSPHERE .....	5-6
5.3.5 STALLING SPEEDS .....	5-7
5.3.6 WIND COMPONENTS .....	5-8
5.3.7 TAKE-OFF DISTANCE .....	5-9
5.3.8 CLIMB PERFORMANCE - TAKE-OFF CLIMB .....	5-13
5.3.9 CLIMB PERFORMANCE - CRUISE CLIMB .....	5-15
5.3.10 CRUISING (TRUE AIRSPEED TAS) .....	5-17
5.3.11 LANDING DISTANCE - FLAPS LDG .....	5-18
5.3.12 LANDING DISTANCE - FLAPS UP .....	5-22
5.3.13 GRADIENT OF CLIMB ON GO-AROUND .....	5-26
5.3.14 GLIDE PERFORMANCE .....	5-26
5.3.15 APPROVED NOISE DATA .....	5-27

## **5.1 INTRODUCTION**

The performance tables and diagrams on the following pages are presented so that, on the one hand, you can see what performance you can expect from your airplane, while on the other they allow comprehensive and sufficiently accurate flight planning. The values in the tables and the diagrams were obtained in the framework of the flight trials using an airplane and power-plant in good condition, and corrected to the conditions of the International Standard Atmosphere (ISA = 15 °C/59 °F and 1,013.25 hPa/29.92 inHg at sea level).

The performance diagrams do not take into account variations in pilot experience or a poorly maintained airplane. The performances given can be attained if the procedures quoted in this manual are applied, and the airplane has been well maintained.

Where appropriate, any flight performance degradation resulting from the absence of wheel fairings is given as a percentage.

## **5.2 USE OF THE PERFORMANCE TABLES AND DIAGRAMS**

In order to illustrate the influence of a number of different variables, the performance data is reproduced in the form of tables or diagrams. These contain sufficiently detailed information so that conservative values can be selected and used for the determination of adequate performance data for the planned flight.

- The installation of the optional fairings on the main landing gear struts and/or nose landing gear strut has only minor effects on the flight performance of the DA 40 D. Therefore,
- no change applies to the performance tables and diagrams.

**5.3 PERFORMANCE TABLES AND DIAGRAMS**

**5.3.1 AIRSPEED CALIBRATION**

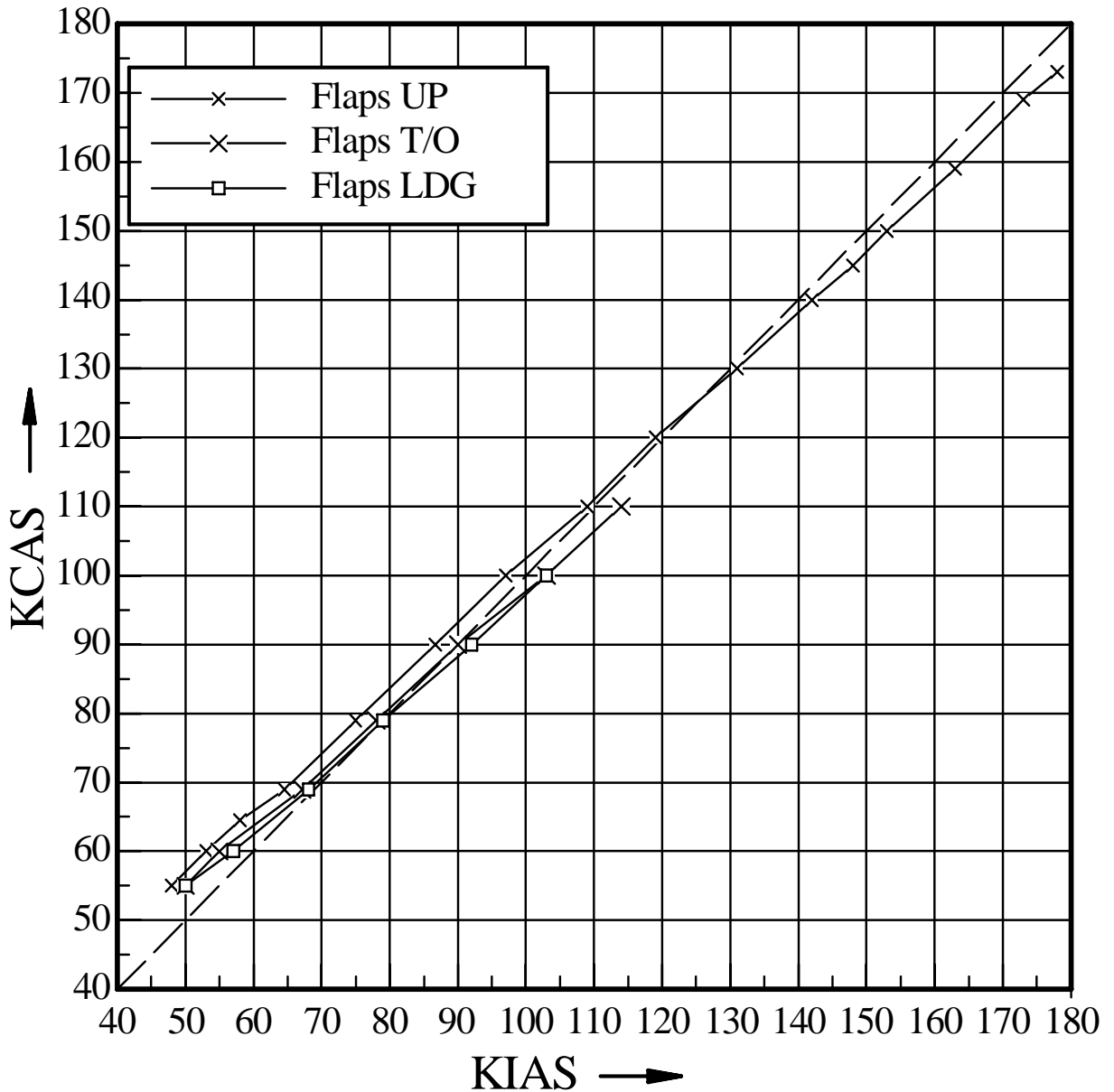

**5.3.2 DIAGRAM FOR SETTING ENGINE PERFORMANCE**

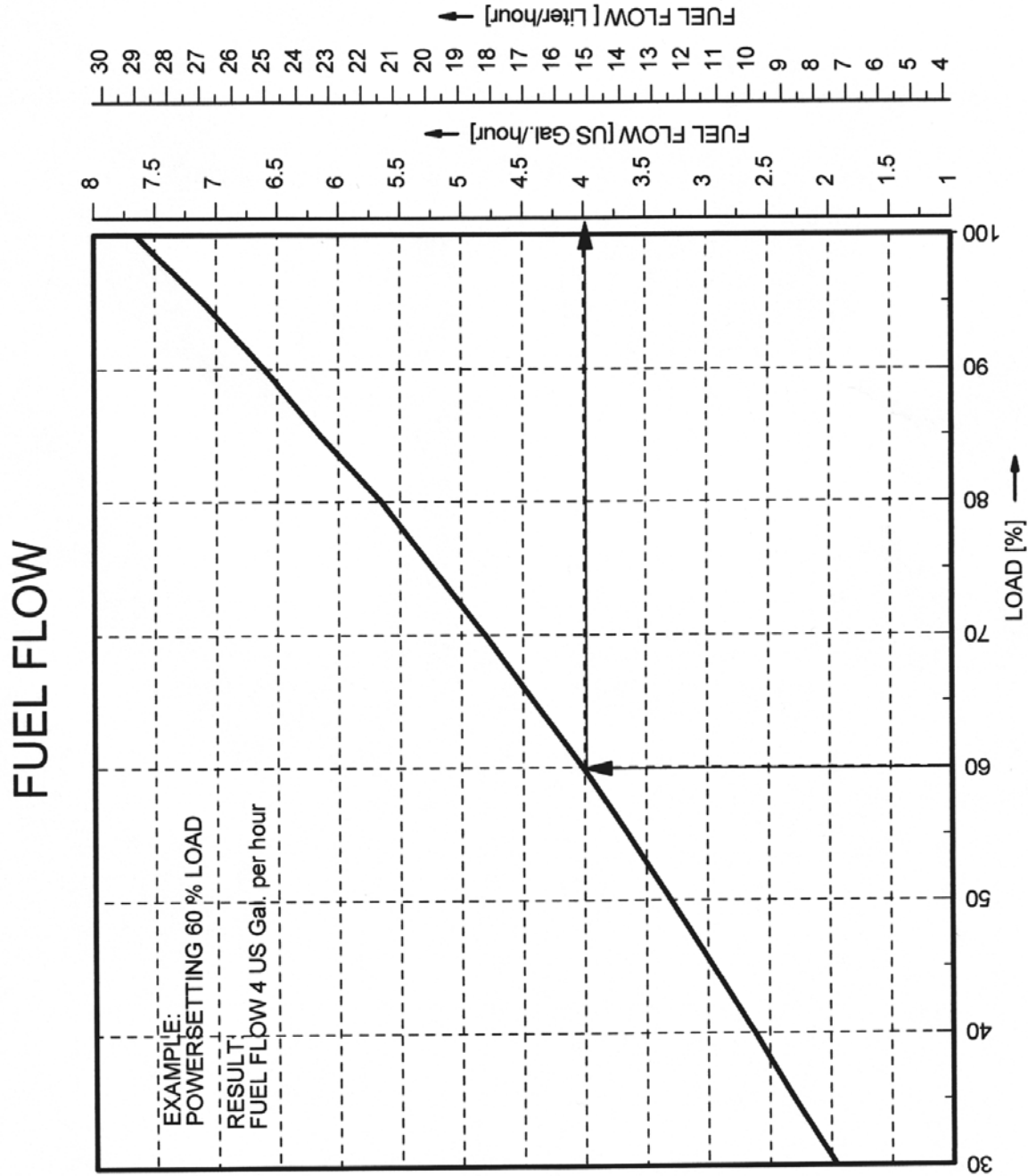



### 5.3.3 PRESSURE ALTITUDE - DENSITY ALTITUDE

Conversion from pressure altitude to density altitude.

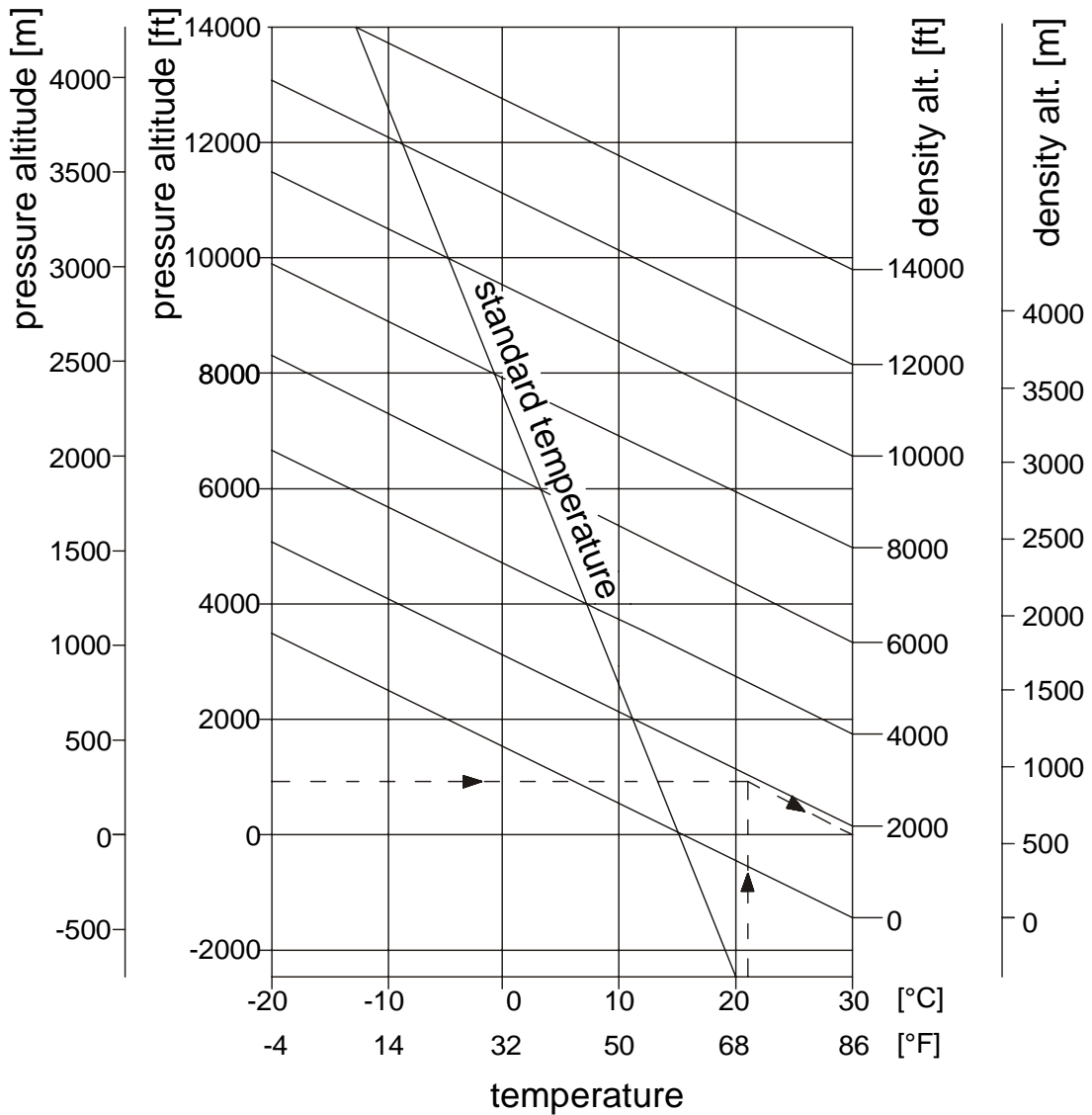

- Example:
1. Set 1,013.25 hPa on altimeter and read pressure altitude (900 ft).
  2. Establish ambient temperature (+21 °C).
  3. Read off density altitude (1800 ft).

Result: From a performance calculation standpoint the airplane is at 1800 ft.

5.3.4 INTERNATIONAL STANDARD ATMOSPHERE

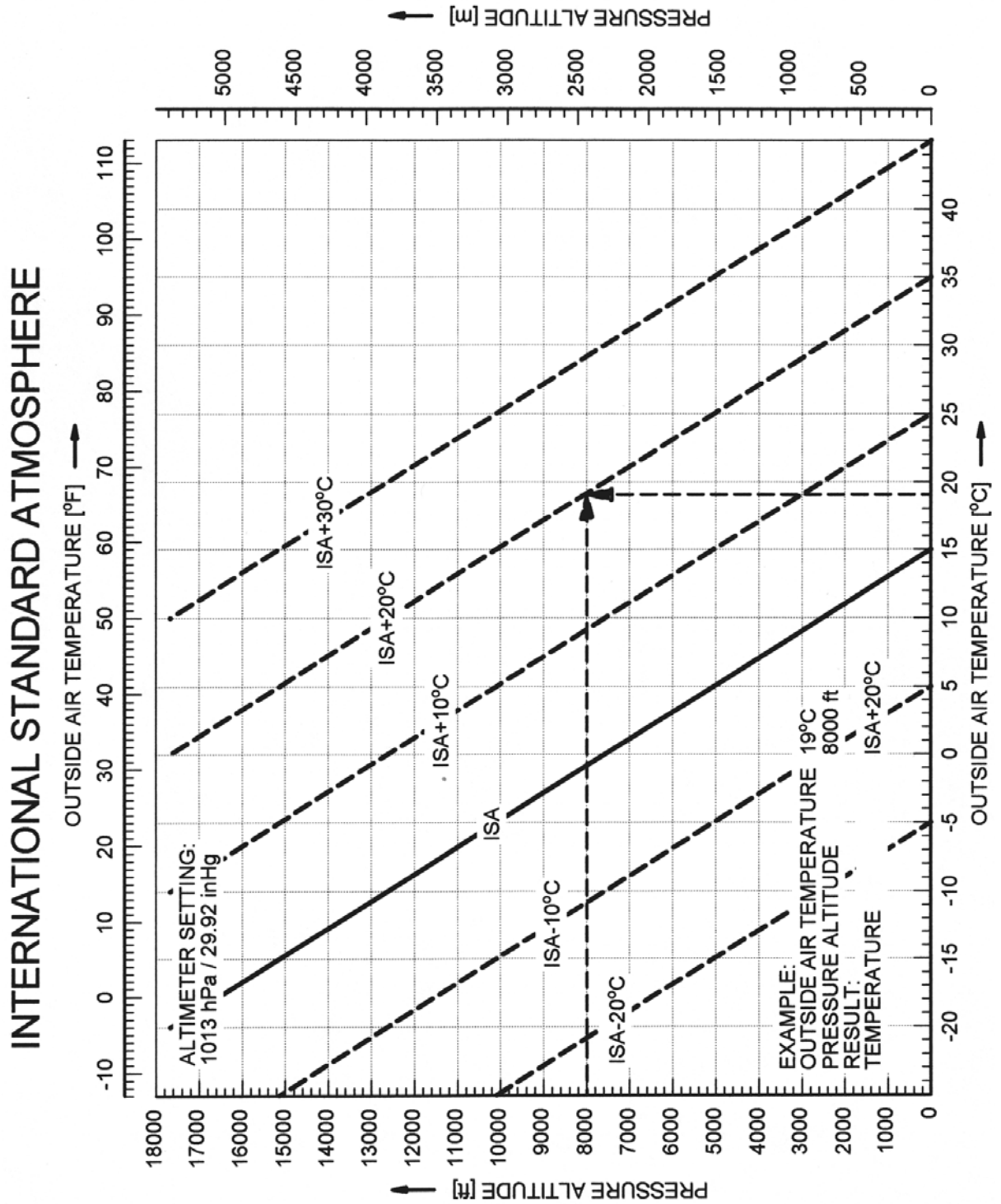

### 5.3.5 STALLING SPEEDS

Mass: 980 kg (2161 lb)

Airspeeds in KIAS

980 kg		Bank Angle			
		0°	30°	45°	60°
Flaps	UP	47	52	58	73
	T/O	44	51	58	72
	LDG	42	49	57	71

Mass: 1150 kg (2535 lb)

Airspeeds in KIAS

1150 kg		Bank Angle			
		0°	30°	45°	60°
Flaps	UP	52	57	66	79
	T/O	51	55	64	78
	LDG	49	55	62	76

**5.3.6 WIND COMPONENTS**

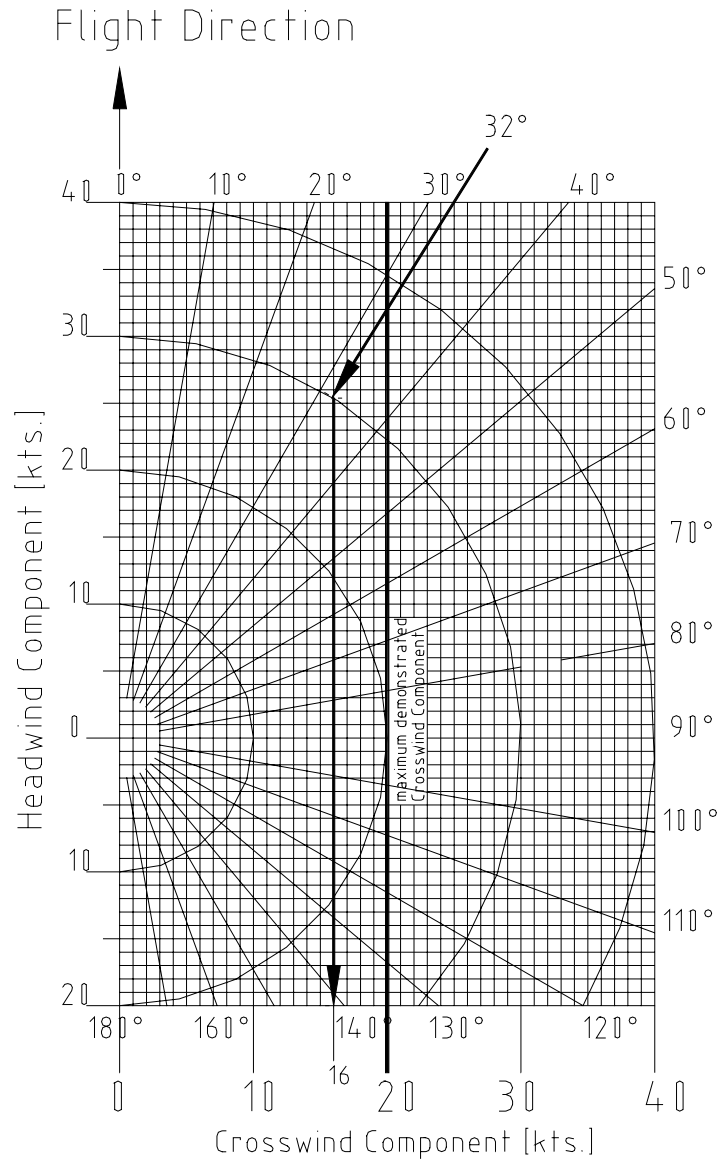

Example: Flight direction : 360°  
 Wind : 32°/30 kts  
 Result: Crosswind component : 16 kts  
 Max. demonstrated crosswind component : 20 kts

### 5.3.7 TAKE-OFF DISTANCE

- Conditions:
- Power lever ..... MAX
  - Flaps ..... T/O
  - Nose wheel lift-off ..... at  $v_R = 59$  KIAS (1150 kg, 2535 lb)  
 at  $v_R = 55$  KIAS (1000 kg, 2205 lb)  
 at  $v_R = 49$  KIAS (850 kg, 1874 lb)
  - Airspeed for initial climb ..... 66 KIAS (1150 kg, 2535 lb)  
 60 KIAS (1000 kg, 2205 lb)  
 54 KIAS (850 kg, 1874 lb)
  - Runway ..... level, asphalt surface

#### **WARNING**

Poor maintenance condition of the airplane, deviation from the given procedures as well as unfavorable outside conditions (high temperature, rain, unfavorable wind conditions, including cross-wind) will increase the take-off distance.

#### **CAUTION**

For a safe take-off the available runway length must be at least equal to the take-off distance over a 50 ft (15 m) obstacle.

#### **CAUTION**

The figures in the following NOTE are typical values. On wet ground or wet soft grass covered runways the take-off roll may become significantly longer than stated below. In any case the pilot must allow for the condition of the runway to ensure a safe take-off.

**NOTE**

For take-off from dry, short-cut grass covered runways, the following corrections must be taken into account, compared to paved runways (typical values, see CAUTION above):

- grass up to 5 cm (2 in) long: 10 % increase in take-off roll.
- grass 5 to 10 cm (2 to 4 in) long: 15 % increase in take-off roll.
- grass longer than 10 cm (4 in): at least 25 % increase in take-off roll.

**NOTE**

An uphill slope of 2 % (2 m per 100 m or 2 ft per 100 ft) results in an increase in the take-off distance of approximately 10 %. The effect on the take-off roll can be greater.

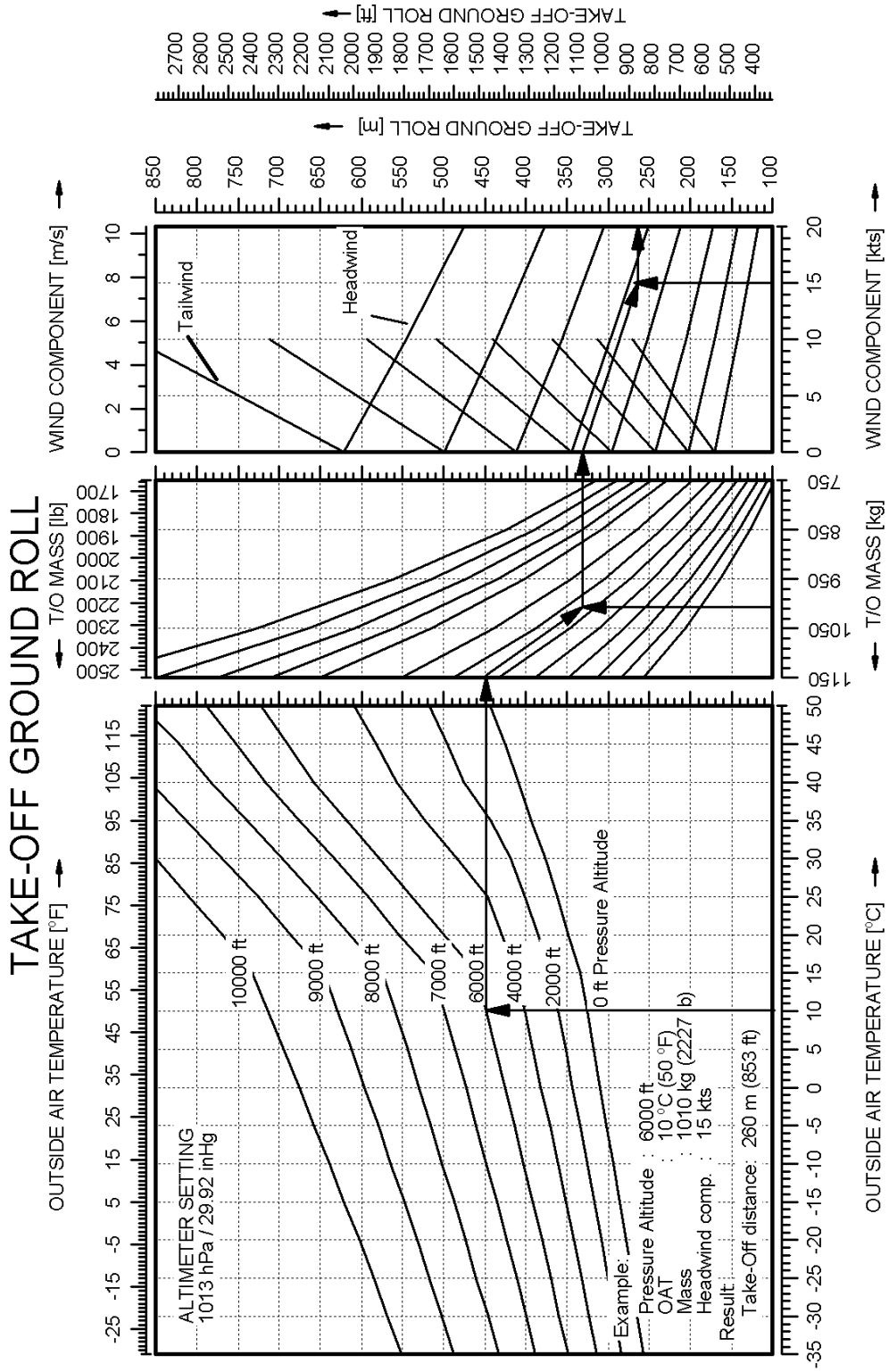

### TAKE-OFF DISTANCE OVER 50 ft OBSTACLE

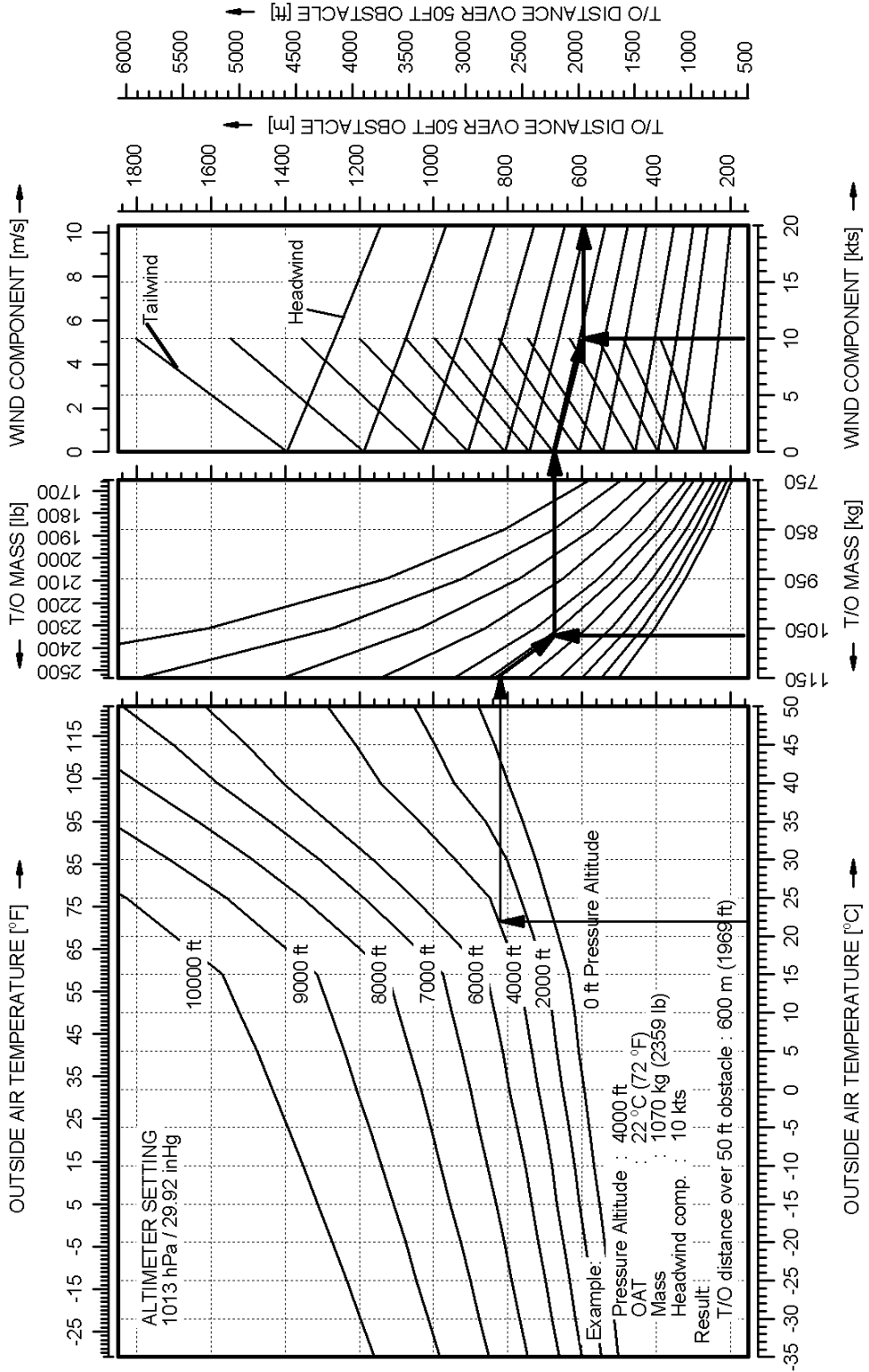





# CLIMB PERFORMANCE - TAKE-OFF CLIMB

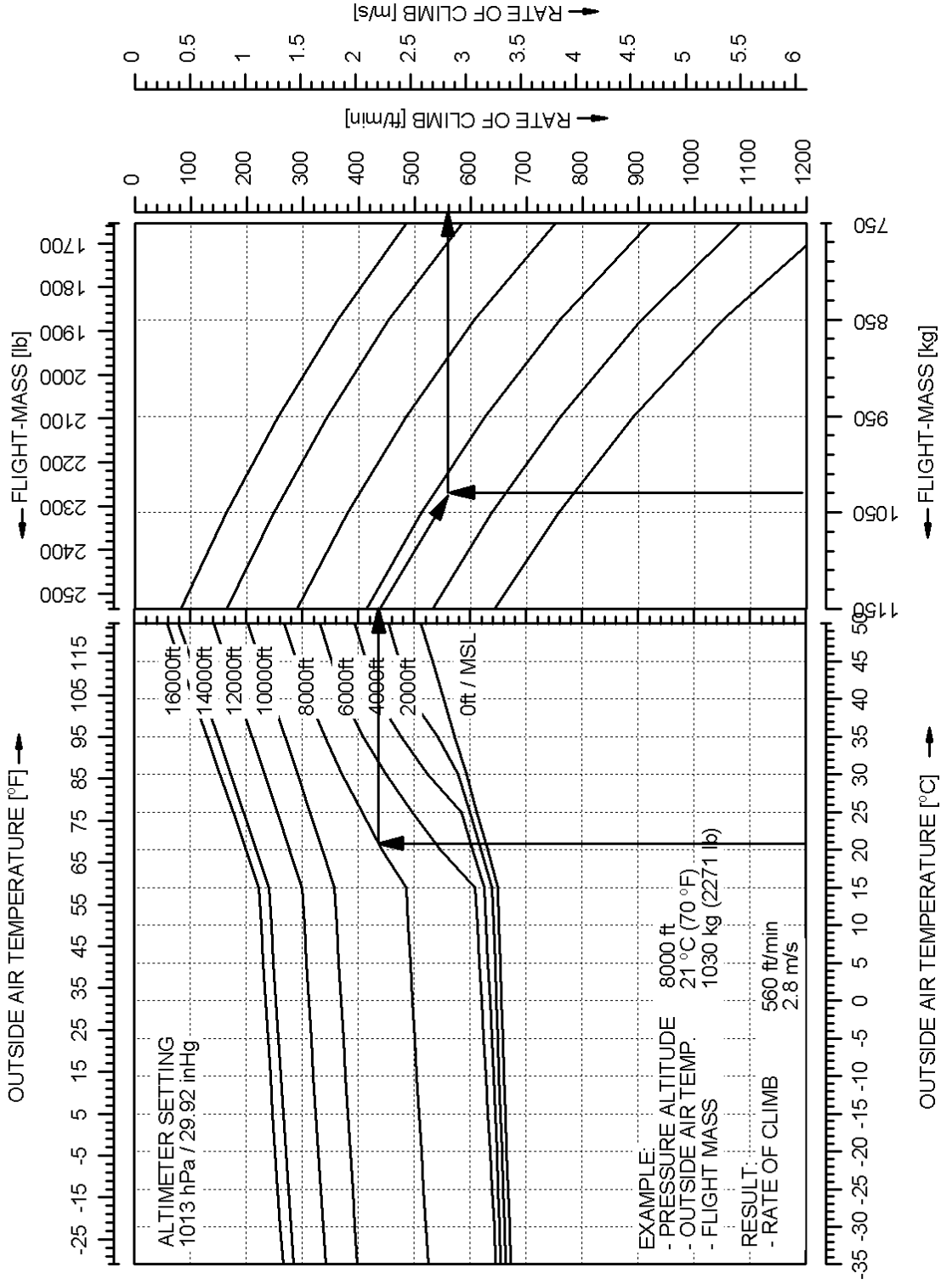

### 5.3.9 CLIMB PERFORMANCE - CRUISE CLIMB

- Conditions:
- Power lever ..... MAX
  - Flaps ..... UP
  - Airspeed ..... 73 KIAS (1150 kg, 2535 lb)  
68 KIAS (1000 kg, 2205 lb)  
60 KIAS (850 kg, 1874 lb)
  - Altitude ..... 0 up to 8500 ft pressure altitude

### NOTE

The graph on the following page shows the *rate* of climb. The *gradient* of climb cannot easily be determined with a graph, but it can be calculated using the following formulae:

$$\text{Gradient [\%]} = \frac{\text{ROC [fpm]}}{\text{TAS [KTAS]}} \cdot 0.95$$

$$\text{Gradient [\%]} = \frac{\text{ROC [m/s]}}{\text{TAS [KTAS]}} \cdot 190$$

# CLIMB PERFORMANCE - CRUISE CLIMB

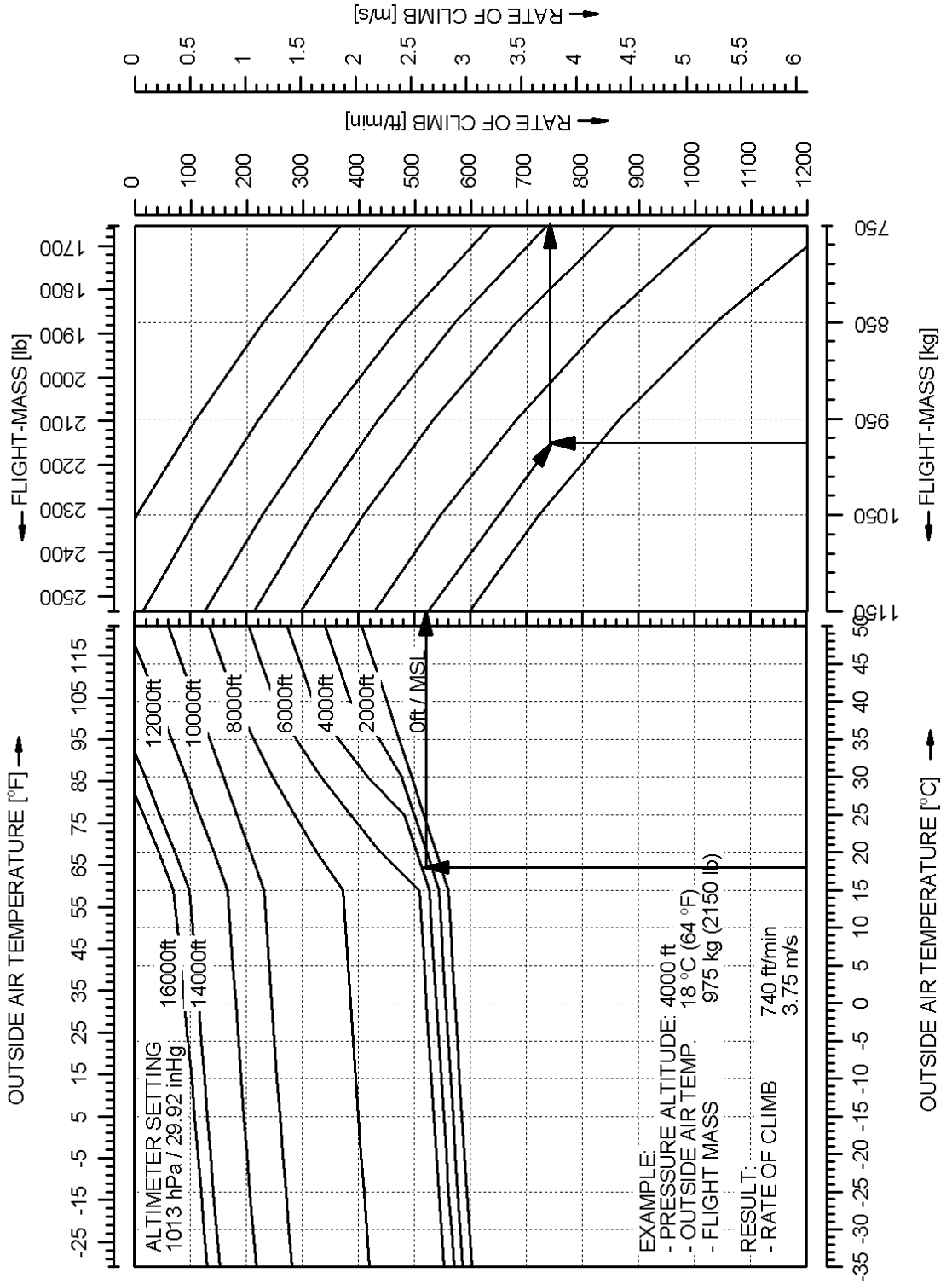

5.3.10 CRUISING (TRUE AIRSPEED TAS)

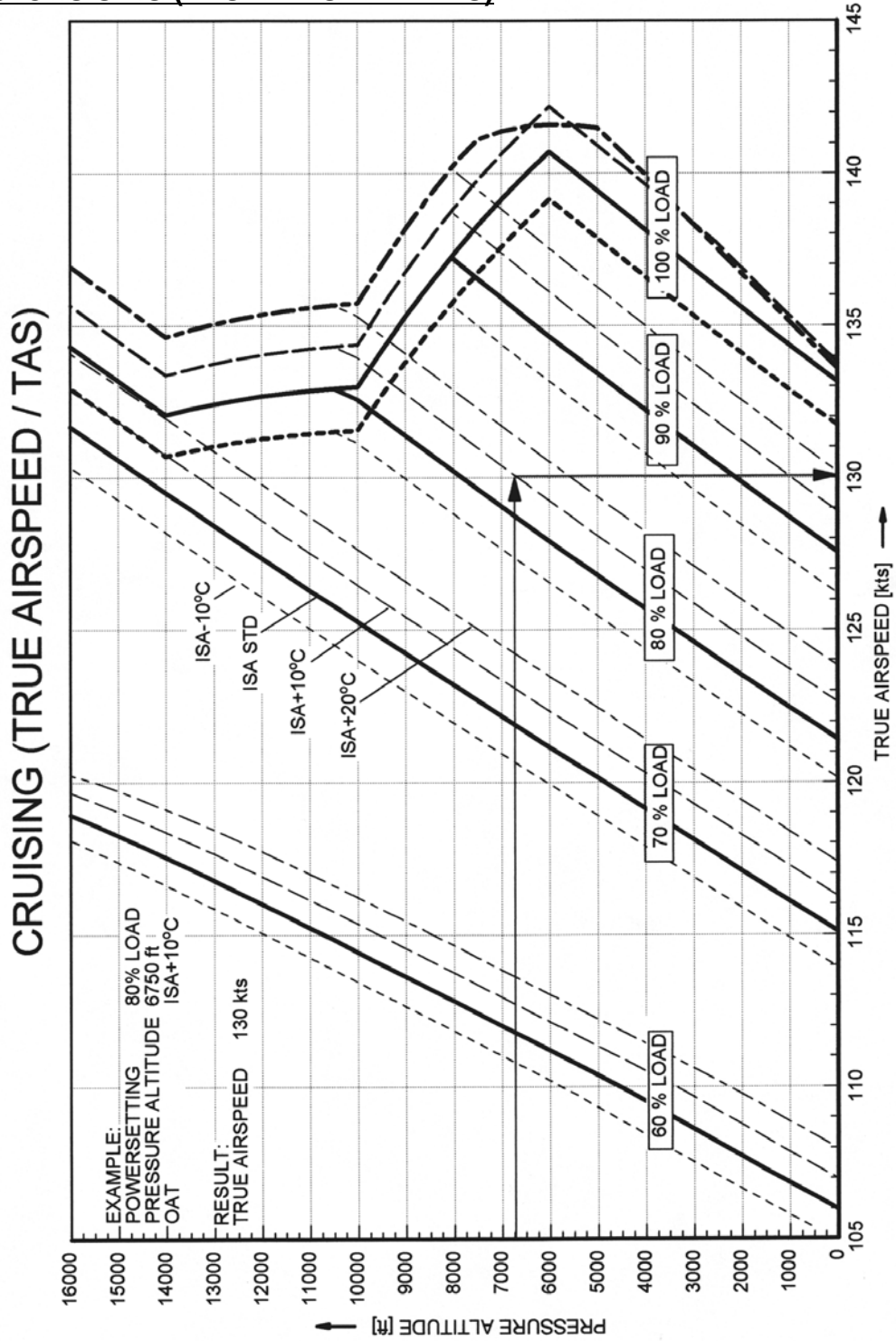

**5.3.11 LANDING DISTANCE - FLAPS LDG**

- Conditions:
- Power lever ..... IDLE
  - Flaps ..... LDG
  - Approach speed ..... 71 KIAS (1150 kg, 2535 lb)  
63 KIAS (1000 kg, 2205 lb)  
58 KIAS (850 kg, 1874 lb)
  - Runway ..... level, asphalt surface

values for ISA and MSL, at 1150 kg (2535 lb)	
Landing distance over a 50 ft (15 m) obstacle	744 m (2441 ft)
Ground roll	287 m (942 ft)

**WARNING**

Poor maintenance condition of the airplane, deviation from the given procedures as well as unfavorable outside conditions (high temperature, rain, unfavorable wind conditions, including cross-wind) will increase the landing distance.

**CAUTION**

For a safe landing the available runway length must be at least equal to the landing distance over a 50 ft (15 m) obstacle.

**CAUTION**

The figures in the following NOTE are typical values. On wet ground or wet soft grass covered runways the landing distance may become significantly longer than stated below. In any case the pilot must allow for the condition of the runway to ensure a safe landing.

**NOTE**

For landings on dry, short-cut grass covered runways, the following corrections must be taken into account, compared to paved runways:

- grass up to 5 cm (2 in) long: 5 % increase in landing roll.
- grass 5 to 10 cm (2 to 4 in) long: 15 % increase in landing roll.
- grass longer than 10 cm (4 in): at least 25 % increase in landing roll.

**NOTE**

A downhill slope of 2 % (2 m per 100 m or 2 ft per 100 ft) results in an increase in the landing distance of approximately 10 %. The effect on the landing roll can be greater.

**NOTE**

Higher approach speeds result in a significant longer landing distance during flare.

LANDING DISTANCE OVER 50 ft OBSTACLE / FLAPS LDG

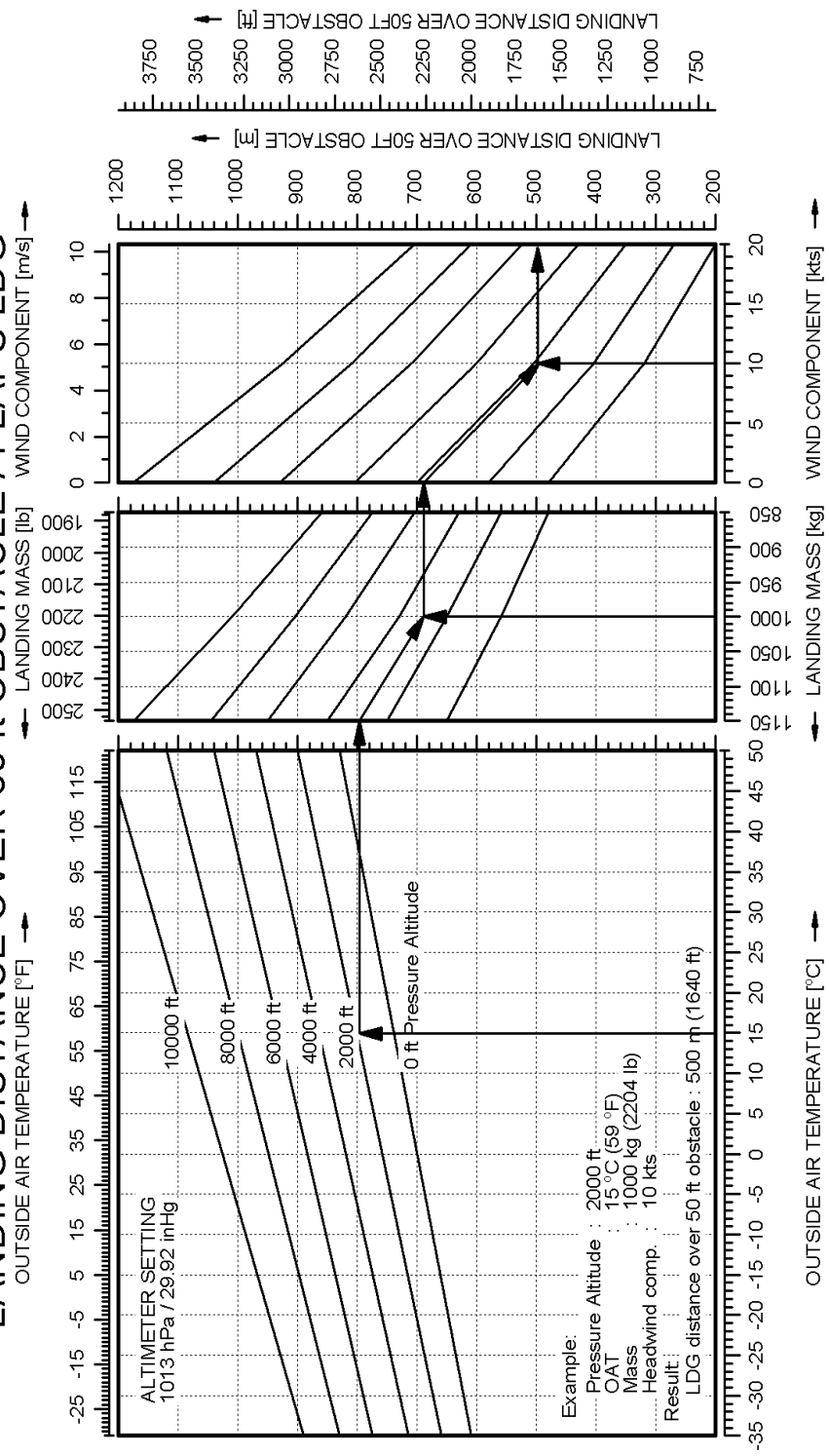



LANDING GROUND ROLL / FLAPS LDG

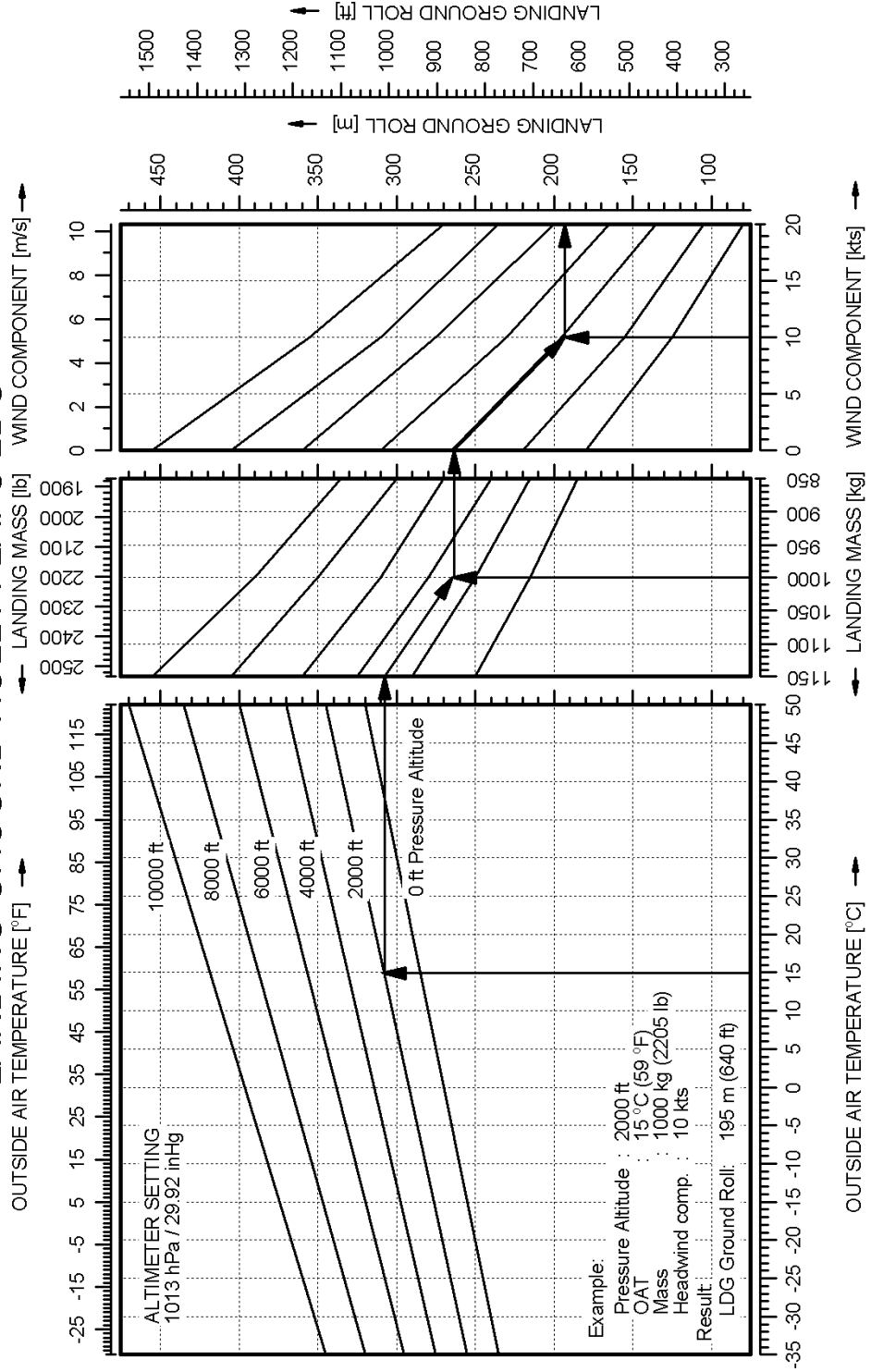

**5.3.12 LANDING DISTANCE - FLAPS UP**

- Conditions:
- Power lever ..... IDLE
  - Flaps ..... UP
  - Approach speed ..... 71 KIAS (1150 kg, 2535 lb)  
63 KIAS (1000 kg, 2205 lb)  
58 KIAS (850 kg, 1874 lb)
  - Runway ..... level, asphalt surface

values for ISA and MSL, at 1150 kg (2535 lb)	
Landing distance over a 50 ft (15 m) obstacle	916 m (3005 ft)
Ground roll	304 m (977 ft)

**WARNING**

Poor maintenance condition of the airplane, deviation from the given procedures as well as unfavorable outside conditions (high temperature, rain, unfavorable wind conditions, including cross-wind) will increase the landing distance.

**CAUTION**

For a safe landing the available runway length must be at least equal to the landing distance over a 50 ft (15 m) obstacle.

**CAUTION**

The figures in the following NOTE are typical values. On wet ground or wet soft grass covered runways the landing distance may become significantly longer than stated below. In any case the pilot must allow for the condition of the runway to ensure a safe landing.

**NOTE**

For landings on dry, short-cut grass covered runways, the following corrections must be taken into account, compared to paved runways:

- grass up to 5 cm (2 in) long: 5 % increase in landing roll.
- grass 5 to 10 cm (2 to 4 in) long: 15 % increase in landing roll.
- grass longer than 10 cm (4 in): at least 25 % increase in landing roll.

**NOTE**

A downhill slope of 2 % (2 m per 100 m or 2 ft per 100 ft) results in an increase in the landing distance of approximately 10 %. The effect on the landing roll can be greater.

**NOTE**

Higher approach speeds result in a significant longer landing distance during flare.

**LANDING DISTANCE OVER 50 ft OBSTACLE / FLAPS UP**

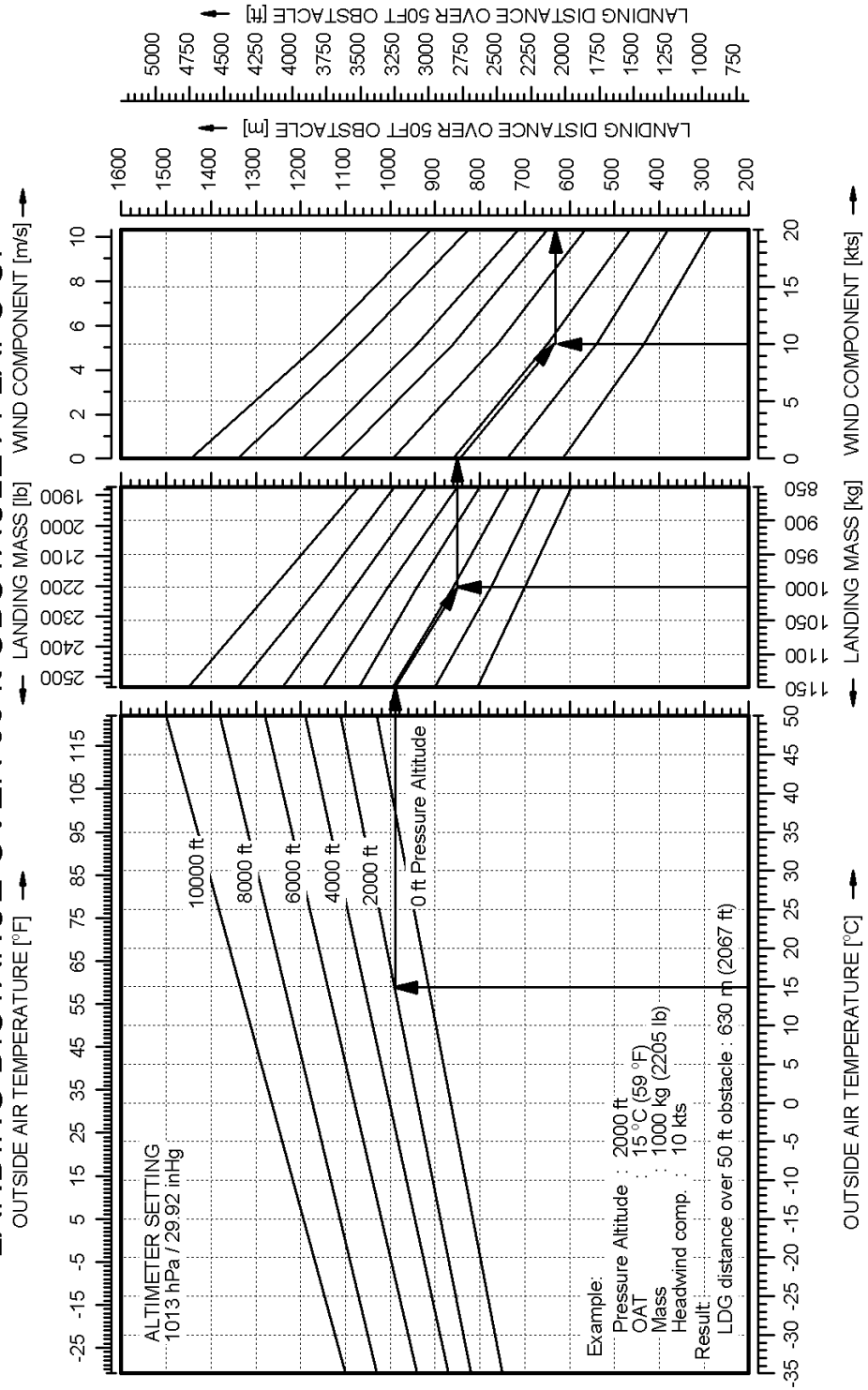

LANDING GROUND ROLL / FLAPS UP

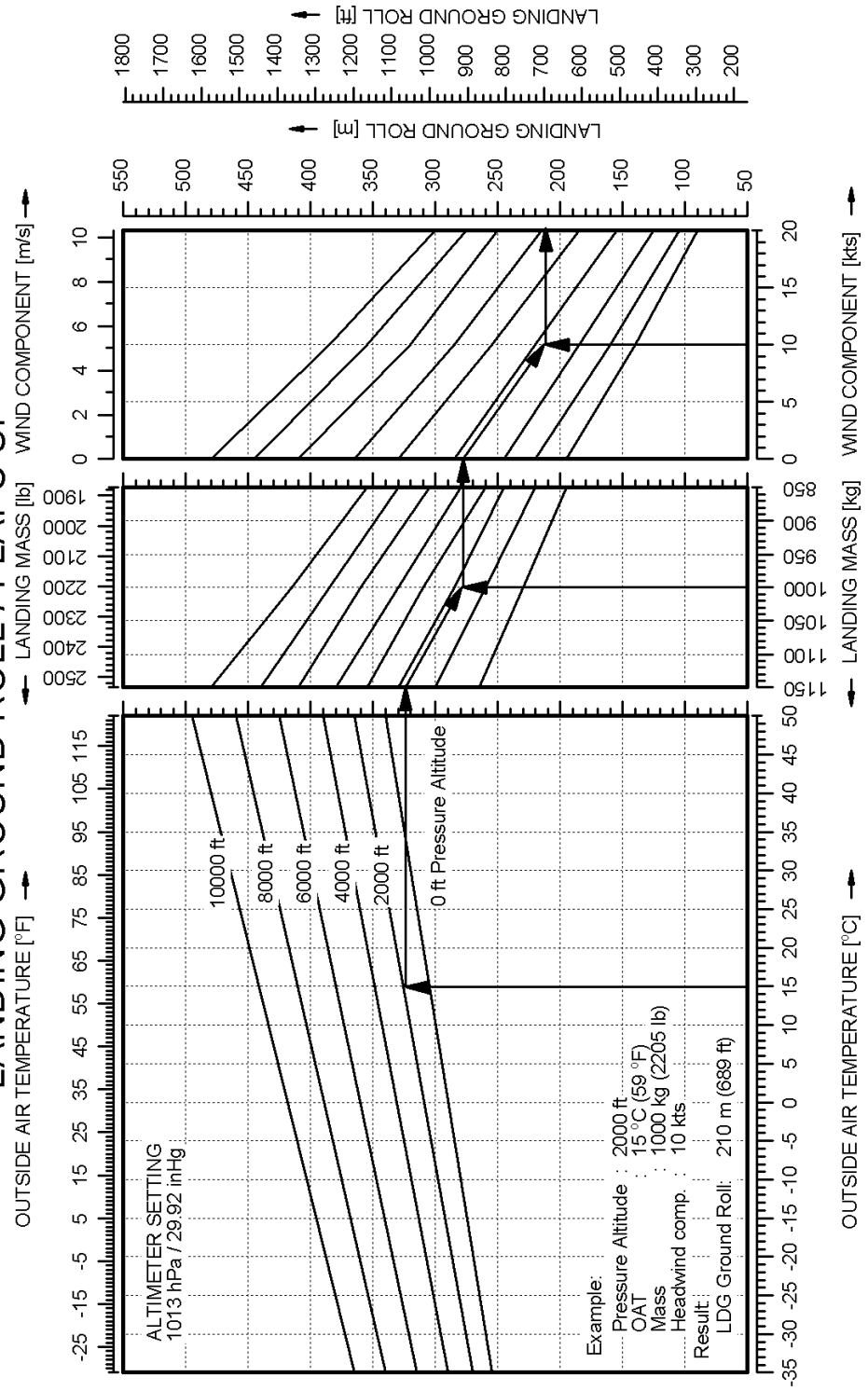

**5.3.13 GRADIENT OF CLIMB ON GO-AROUND**

The DA 40 D reaches a constant gradient of climb of 4.86 % (conforming to an angle of 2.8°) in the following condition:

- Mass ..... max. flight mass  
(1150 kg, 2535 lb)
- Power lever ..... MAX
- Flaps ..... LDG
- Airspeed ..... 70 KIAS
- ISA, MSL

**5.3.14 GLIDE PERFORMANCE**

The following table shows the glide ratio and the resulting maximum horizontal distance in nautical miles per 1000 ft of altitude loss in a glide traveled in still air.

	Glide ratio	Maximum horizontal distance per 1000 ft altitude loss
Windmilling propeller	8.8	1.45 NM (2.68 km)
Stationary propeller	10.3	1.70 NM (3.14 km)

- Airspeed ..... 73 KIAS (1150 kg, 2535 lb)  
68 KIAS (1000 kg, 2205 lb)  
60 KIAS ( 850 kg, 1874 lb)

**5.3.15 APPROVED NOISE DATA**

*If TAE 125-01 engine is installed:*

*With exhaust pipe:*

ICAO Annex 16 Chapter X .....	78.7 dB(A)
JAR-36 Subpart C .....	78.7 dB(A)

*With muffler:*

ICAO Annex 16 Chapter X .....	69.5 dB(A)
JAR-36 Subpart C .....	69.5 dB(A)

■ *If TAE 125-02-99 engine is installed (if MÄM 40-256 carried out):*

■ ICAO Annex 16 Chapter X .....	73.0 dB(A)
■ JAR-36 Subpart C .....	73.0 dB(A)

Intentionally left blank.



## CHAPTER 6

# MASS AND BALANCE / EQUIPMENT LIST

	Page
6.1 INTRODUCTION .....	6-2
6.2 DATUM PLANE .....	6-3
6.3 MASS AND BALANCE REPORT .....	6-3
6.4 FLIGHT MASS AND CENTER OF GRAVITY .....	6-5
6.4.1 MOMENT ARMS .....	6-7
6.4.2 LOADING DIAGRAM .....	6-8
6.4.3 CALCULATION OF LOADING CONDITION .....	6-9
6.4.4 PERMISSIBLE CENTER OF GRAVITY RANGE .....	6-11
6.4.5 PERMISSIBLE MOMENT RANGE .....	6-13
6.5 EQUIPMENT LIST AND EQUIPMENT INVENTORY .....	6-15

## **6.1 INTRODUCTION**

In order to achieve the performance and flight characteristics described in this Airplane Flight Manual and for safe flight operation, the airplane must be operated within the permissible mass and balance envelope.

The pilot is responsible for adhering to the permissible values for loading and center of gravity (CG). In this, he should note the movement of the CG due to fuel consumption. The permissible CG range during flight is given in Chapter 2.

The procedure for determining the flight mass CG position is described in this Chapter. Over and above this there is a comprehensive list of the equipment approved for this airplane (Equipment List), as also a list of that equipment installed when the airplane was weighed (Equipment Inventory).

Before the airplane is delivered the empty mass and the corresponding CG position are determined, and entered in Section 6.3 - MASS AND BALANCE REPORT.

### **NOTE**

Following equipment changes the new empty mass and the corresponding CG position must be determined by calculation or by weighing.

Following repairs or repainting the new empty mass and the corresponding CG position must be determined by weighing.

Empty mass, empty mass CG position, and the empty mass moment must be certified in the Mass and Balance Report by an authorized person.

## NOTE

Refer to Section 1.6 UNITS OF MEASUREMENT for conversion of SI units to US units and vice versa.

## **6.2 DATUM PLANE**

The Datum Plane (DP) is a plane which is normal to the airplane's longitudinal axis and in front of the airplane as seen from the direction of flight. The airplane's longitudinal axis is parallel with the upper surface of a 600:31 wedge which is placed on top of the rear fuselage in front of the vertical stabilizer. When the upper surface of the wedge is aligned horizontally, the Datum Plane is vertical. The Datum Plane is located 2.194 meters (86.38 in) forward of the most forward point of the root rib on the stub wing.

## **6.3 MASS AND BALANCE REPORT**

The empty mass and the corresponding CG position established before delivery are the first entries in the Mass and Balance Report. Every change in permanently installed equipment, and every repair to the airplane which affects the empty mass or the empty mass CG must be recorded in the Mass and Balance Report.

For the calculation of flight mass and corresponding CG position (or moment), the *current* empty mass and the corresponding CG position (or moment) in accordance with the Mass and Balance Report must always be used.

Condition of the airplane for establishing the empty mass:

- Equipment as per Equipment Inventory (see Section 6.5)
- Including brake fluid, lubricant (6.0 liters = 6.3 qts), coolant (6.0 liters = 6.3 qts), gearbox oil (0.9 liters = 0.95 qts), plus unusable fuel (2 US gal = approx. 7.6 liters).

**MASS AND BALANCE REPORT**

(Continuous report on structural or equipment changes)

DA 40 D			Serial No.:	Registration:			Page No.:					
Date	Entry No.		Description of Part or Modification	Changes in Mass						Current Empty Mass		
				Addition (+)			Subtraction (-)					
	IN	OUT		Mass	Moment Arm	Moment	Mass	Moment Arm	Moment	Mass	Moment Arm	Moment
				[kg]	[m]	[kgm]	[kg]	[m]	[kgm]	[kg]	[m]	[kgm]
			upon delivery	/	/	/	/	/	/			

## **6.4 FLIGHT MASS AND CENTER OF GRAVITY**

The following information enables you to operate your DA 40 D within the permissible mass and balance limits. For the calculation of the flight mass and the corresponding CG position the following tables and diagrams are required:

- 6.4.1 - MOMENT ARMS
- 6.4.2 - LOADING DIAGRAM
- 6.4.3 - CALCULATION OF LOADING CONDITION
- 6.4.4 - PERMISSIBLE CENTER OF GRAVITY RANGE
- 6.4.5 - PERMISSIBLE MOMENT RANGE

The diagrams should be used as follows:

1. Take the empty mass and the empty mass moment of your airplane from the Mass and Balance Report, and enter the figures in the appropriate boxes under the column marked 'Your DA 40 D' in Table 6.4.3 - CALCULATION OF LOADING CONDITION.
2. Read the fuel quantity indicators to determine the fuel quantity. If an indicator shows 15 US gal, up to 19.5 US gal can be in the Long Range Tank. In this case, the exact quantity must be determined with the alternate mean for fuel quantity indication.
3. Multiply the individual masses by the moment arms quoted to obtain the moment for every item of loading and enter these moments in the appropriate boxes in Table 6.4.3 - CALCULATION OF LOADING CONDITION.
4. Add up the masses and moments in the respective columns. The total moments may be rounded to whole numbers. The CG position is calculated by dividing the total moment by the total mass (using row 5 for the condition with empty fuel tanks, and row 7 for the pre take-off condition). The resulting CG position must be inside the limits.

As an illustration the total mass and the CG position are entered on Diagram 6.4.4 - PERMISSIBLE CENTER OF GRAVITY RANGE. This checks graphically that the current configuration of the airplane is within the permissible range.

5. Graphical method:

Diagram 6.4.2 - LOADING DIAGRAM is used to determine the moments. The masses and moments for the individual items of loading are added. Then Diagram 6.4.5 - PERMISSIBLE MOMENT RANGE is used to check whether the total moment associated with the total mass is in the admissible range.

The result found with the graphical method is however inaccurate. In doubtful cases the result must be verified using the exact method given above.

### 6.4.1 MOMENT ARMS

The most important lever arms aft of the Datum Plane:

- Front seats : 2.30 m 90.6 in
- Rear seats : 3.25 m 128.0 in
- Wing tank : 2.63 m 103.5 in
- Baggage : 3.65 m 143.7 in

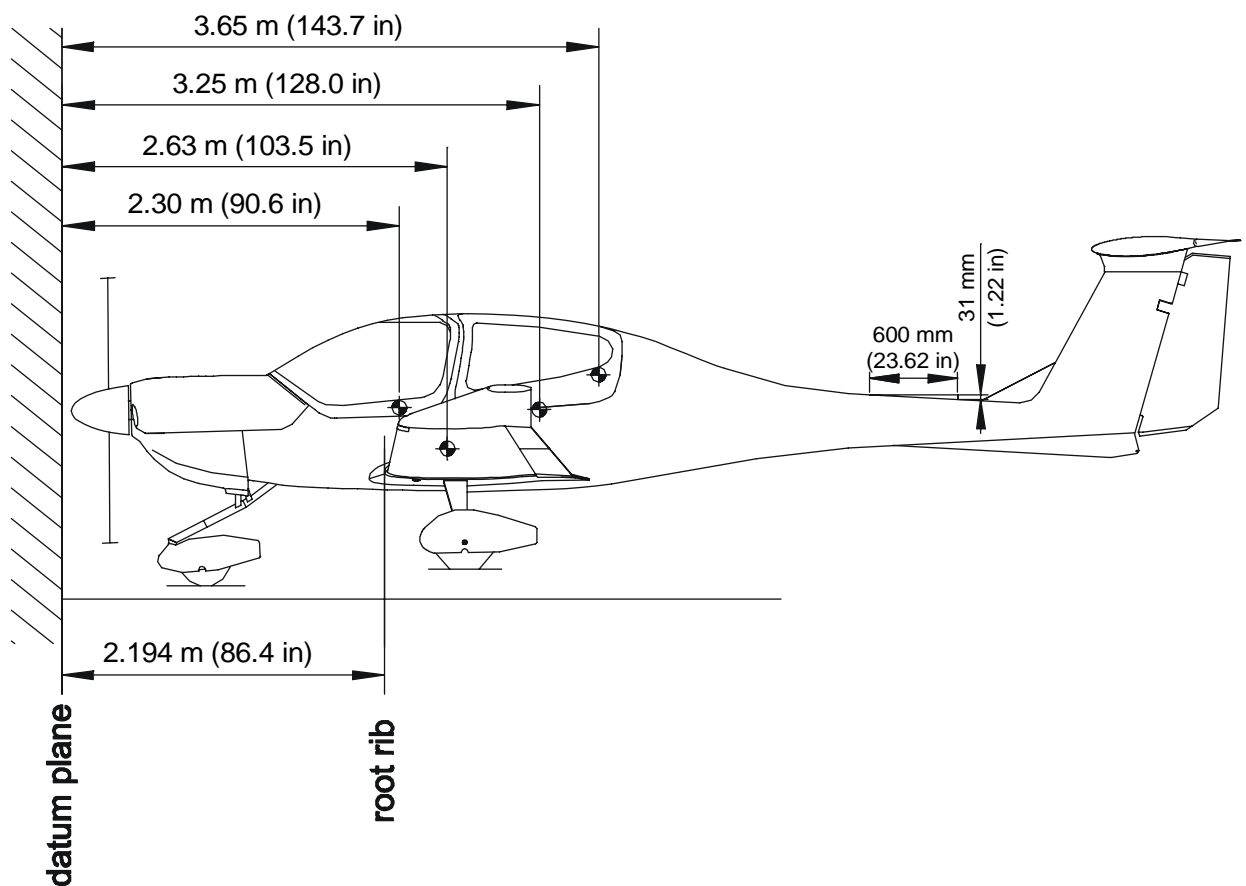

**6.4.2 LOADING DIAGRAM**

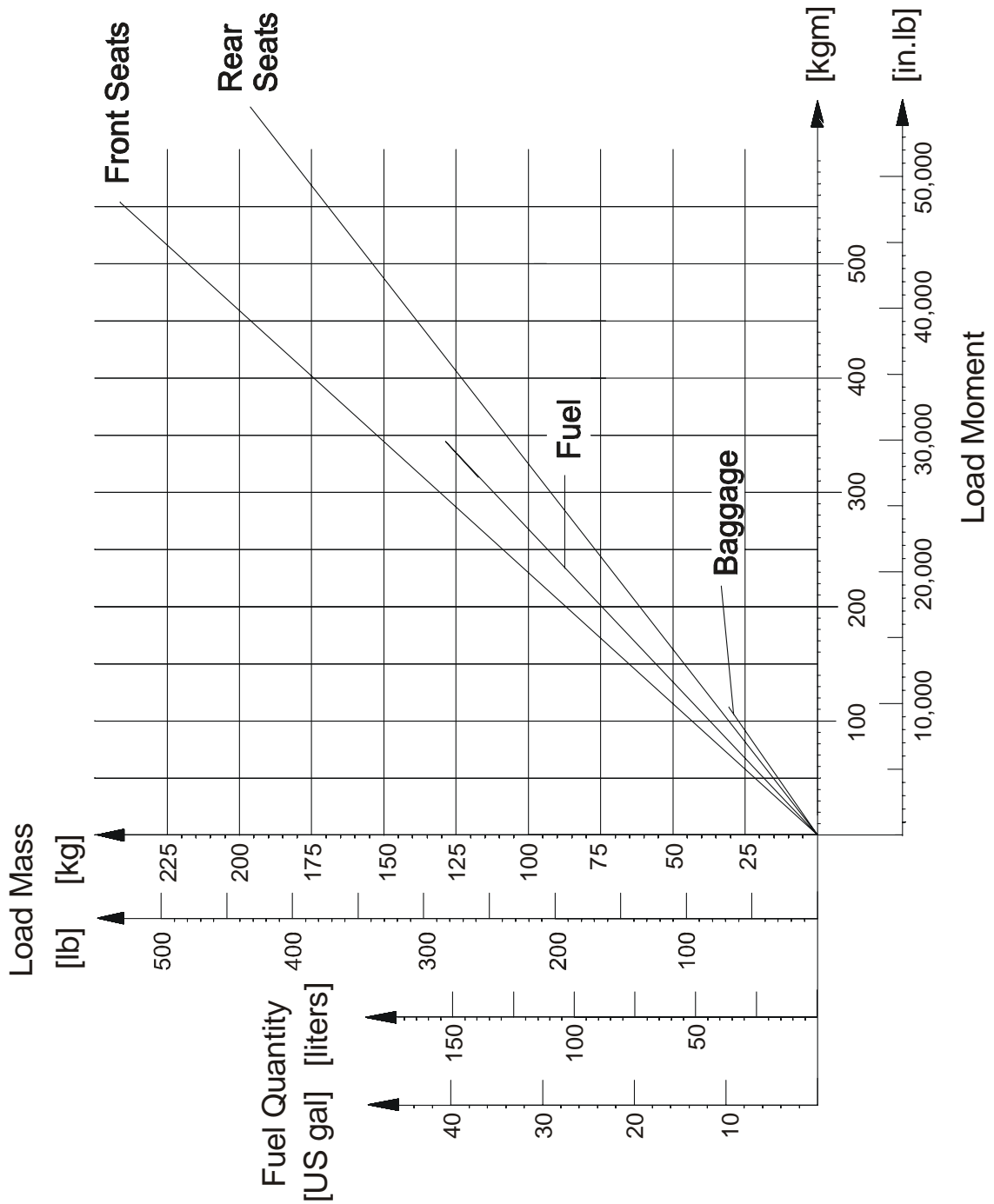



### 6.4.3 CALCULATION OF LOADING CONDITION

#### a) Standard tank

CALCULATION OF LOADING CONDITION	DA 40 D (Example)		Your DA 40 D	
	Mass [kg] [lb]	Moment [kgm] [in.lb]	Mass [kg] [lb]	Moment [kgm] [in.lb]
1. Empty mass (from Mass and Balance Report)	735 1620	1820 158,000		
2. Front seats Lever arm: 2.30 m (90.6 in)	150 331	345 29,989		
3. Rear seats Lever arm: 3.25 m (128.0 in)	150 331	487.5 42,368		
4. Baggage Lever arm: 3.65 m (143.7 in)	0 0	0 0		
5. Total mass and total moment with empty fuel tanks (Total of 1.-4.)	1035 2282	2652.5 230,357		
6. On-board usable fuel (0.84 kg/liter) (7.01 lb/US gal) Lever arm: 2.63 m (103.5 in)	100.8 222	265.10 23,001		
7. Total mass and total moment with full fuel tanks (Total 5. plus 6.)	1135.8 2504	2917.60 253,357		
<p>8. The total moments from rows 5 and 7 (2652.5 and 2917.6 kgm (30,357 and 53,357 in.lb)) must be divided by the related total mass (1035 and 1135.8 kg (2282 and 2504 lb) respectively) and then located in Diagram 6.4.4 - PERMISSIBLE CENTER OF GRAVITY RANGE.</p> <p>As in our example CG positions (2.562 m and 2.569 m (100.95 and 101.18 in) respectively) and masses fall into the permitted area, this loading condition is allowable.</p>				

b) Long Range Tank

CALCULATION OF LOADING CONDITION	DA 40 D (Example)		Your DA 40 D	
	Mass [kg] [lb]	Moment [kgm] [in.lb]	Mass [kg] [lb]	Moment [kgm] [in.lb]
1. Empty mass (from Mass and Balance Report)	735 1620	1820 158,000		
2. Front seats Lever arm: 2.30 m (90.6 in)	150 331	345 29,989		
3. Rear seats Lever arm: 3.25 m (128.0 in)	80 176	260 22,528		
4. Baggage Lever arm: 3.65 m (143.7 in)	0 0	0 0		
5. Total mass and total moment with empty fuel tanks (Total of 1.-4.)	965 2127	2425 210,517		
6. On-board usable fuel (0.84 kg/liter) (7.01 lb/US gal) Lever arm: 2.63 m (103.5 in)	100.8 222	265.10 22,977		
7. Total mass and total moment with full fuel tanks (Total 5. plus 6.)	1065.8 2349	2690.10 233,494		
<p>8. The total moments from rows 5 and 7 (2425 and 2690.1 kgm (210,517 and 233,494 in.lb)) must be divided by the related total mass (965 and 1065.8 kg (2127 and 2349 lb) respectively) and then located in Diagram 6.4.4 - PERMISSIBLE CENTER OF GRAVITY RANGE.</p> <p>As in our example CG positions (2.513 m and 2.524 m (98.97 and 99.40 in) respectively) and masses fall into the permitted area, this loading condition is allowable.</p>				

**6.4.4 PERMISSIBLE CENTER OF GRAVITY RANGE**

a) Standard tank:

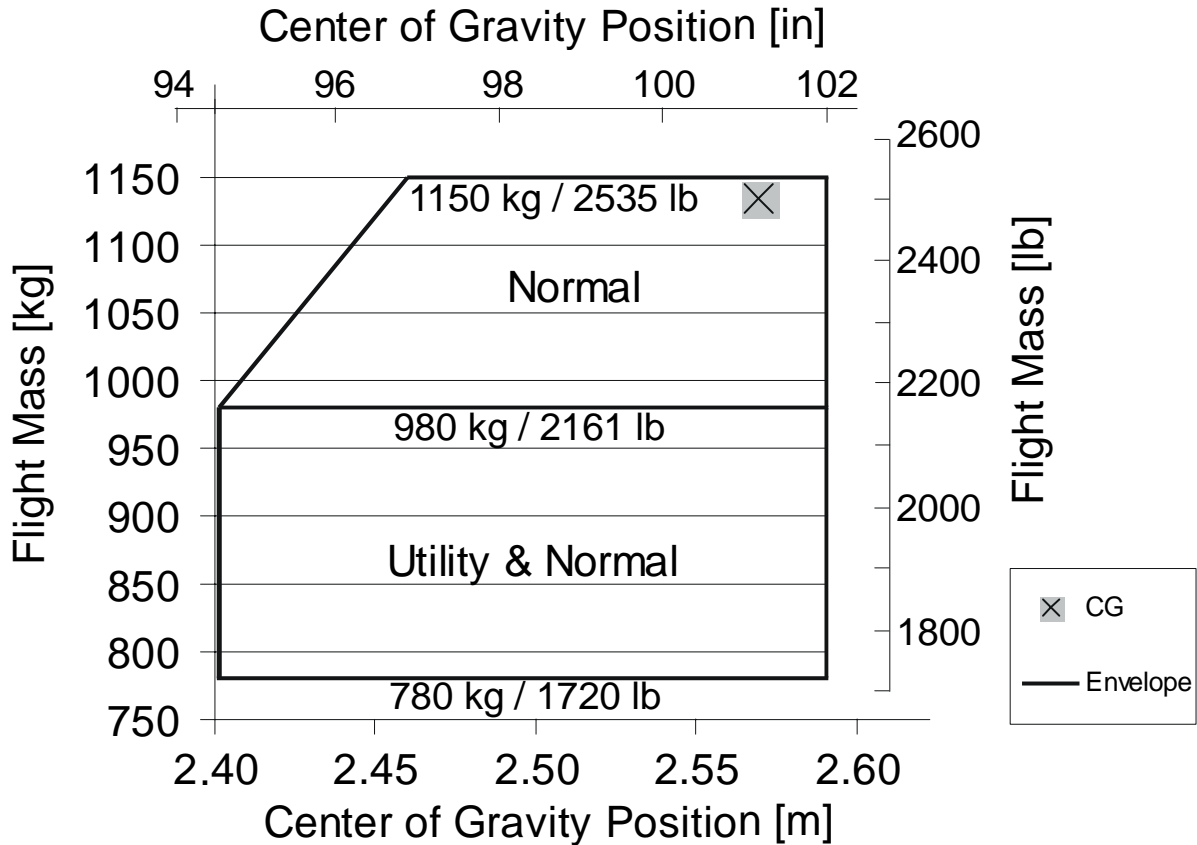

The CG shown in the diagram is that from the example in Table 6.4.3 (a) CALCULATION OF LOADING CONDITION, row 7 (pre take-off condition).

The flight CG position must be within the following limits:

Most forward flight CG:

- 2.40 m (94.5 in) aft of Datum Plane at 780 to 980 kg (1720 to 2161 lb)
- 2.46 m (96.9 in) aft of Datum Plane at 1150 kg (2535 lb)
- linear variation between these values

Most rearward flight CG:

- 2.59 m (102.0 in) aft of Datum Plane

b) Long Range Tank

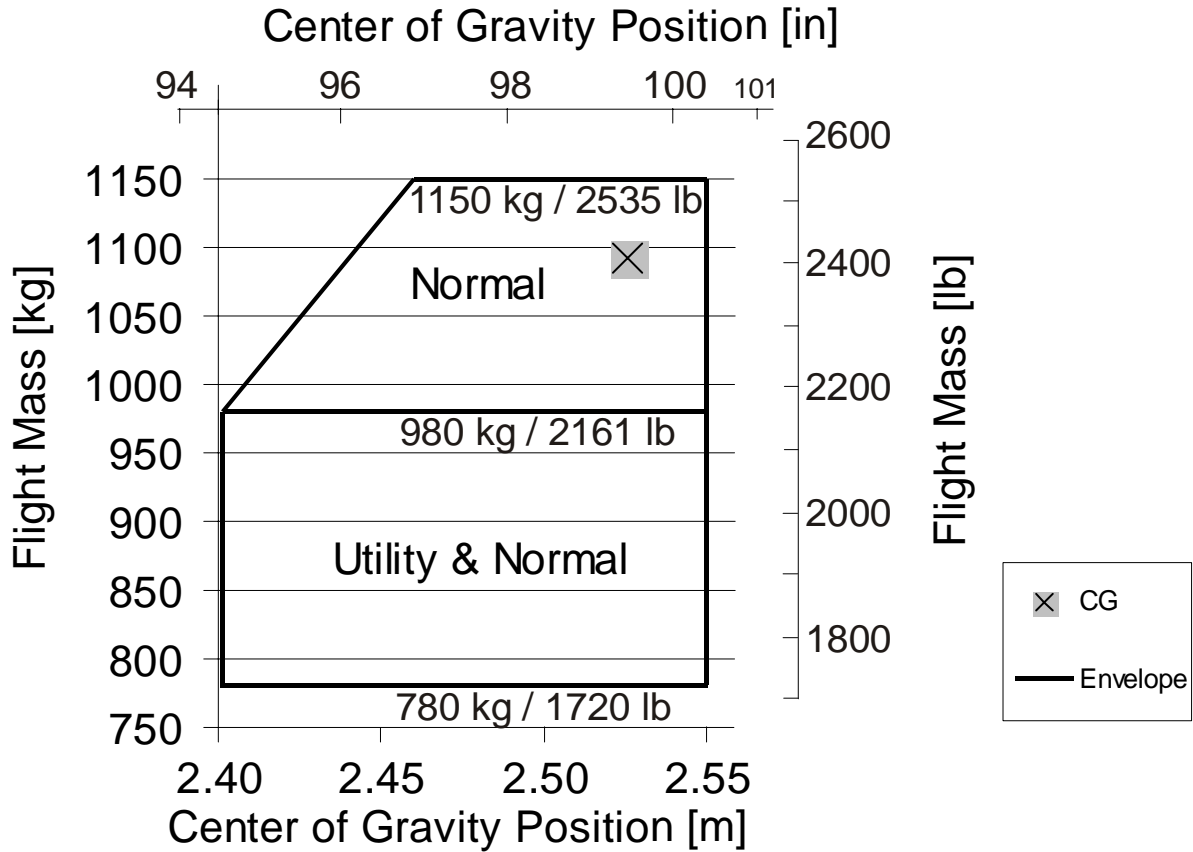

The CG shown in the diagram is that from the example in Table 6.4.3 (b) CALCULATION OF LOADING CONDITION, row 7 (pre take-off condition).

The flight CG position must be within the following limits:

Most forward flight CG:

- 2.40 m (94.5 in) aft of Datum Plane at 780 to 980 kg (1720 to 2161 lb)
- 2.46 m (96.9 in) aft of Datum Plane at 1150 kg (2535 lb)
- linear variation between these values

Most rearward flight CG:

- 2.55 m (102.0 in) aft of Datum Plane

**6.4.5 PERMISSIBLE MOMENT RANGE**

a) Standard tank

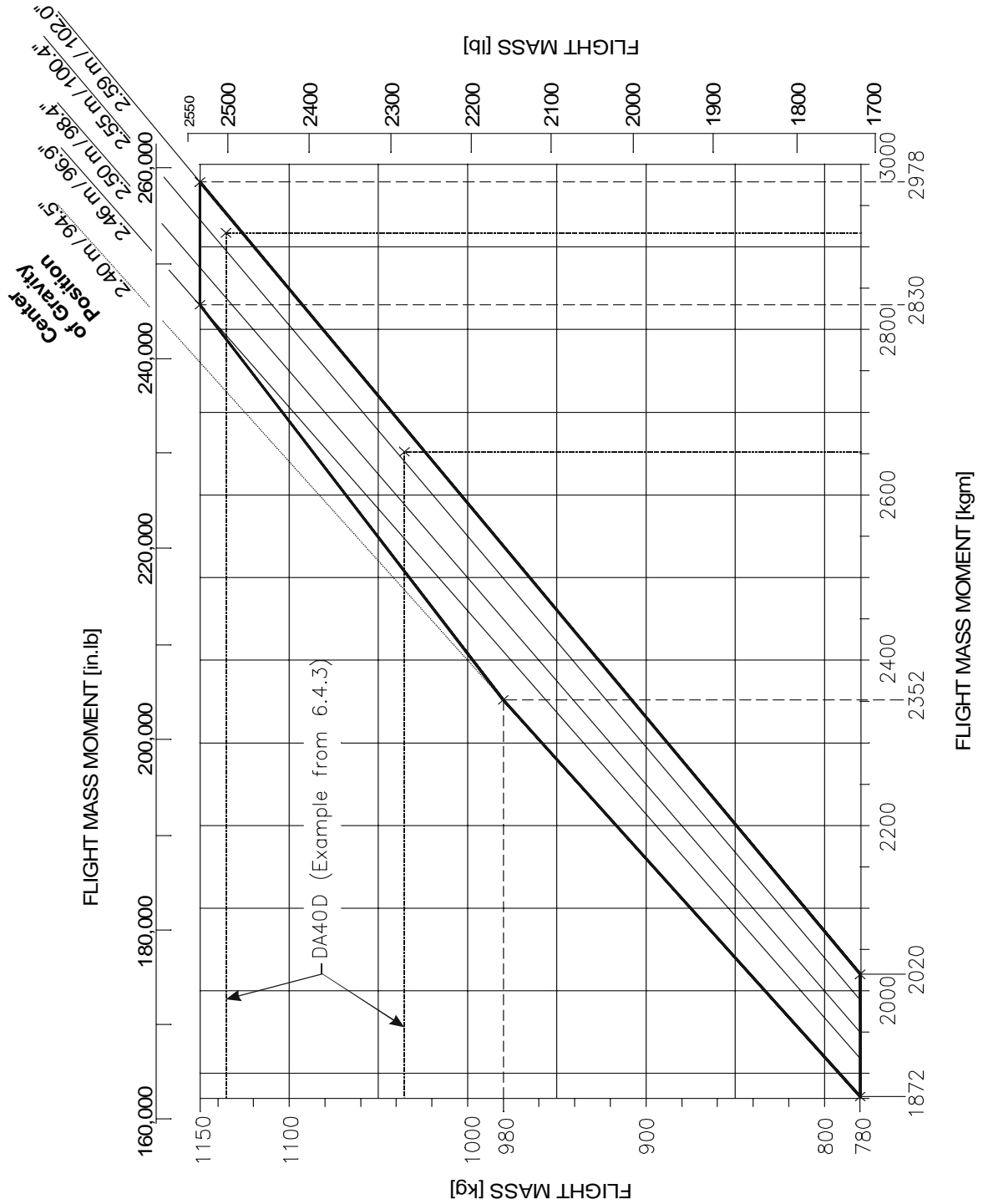

b) Long Range Tank

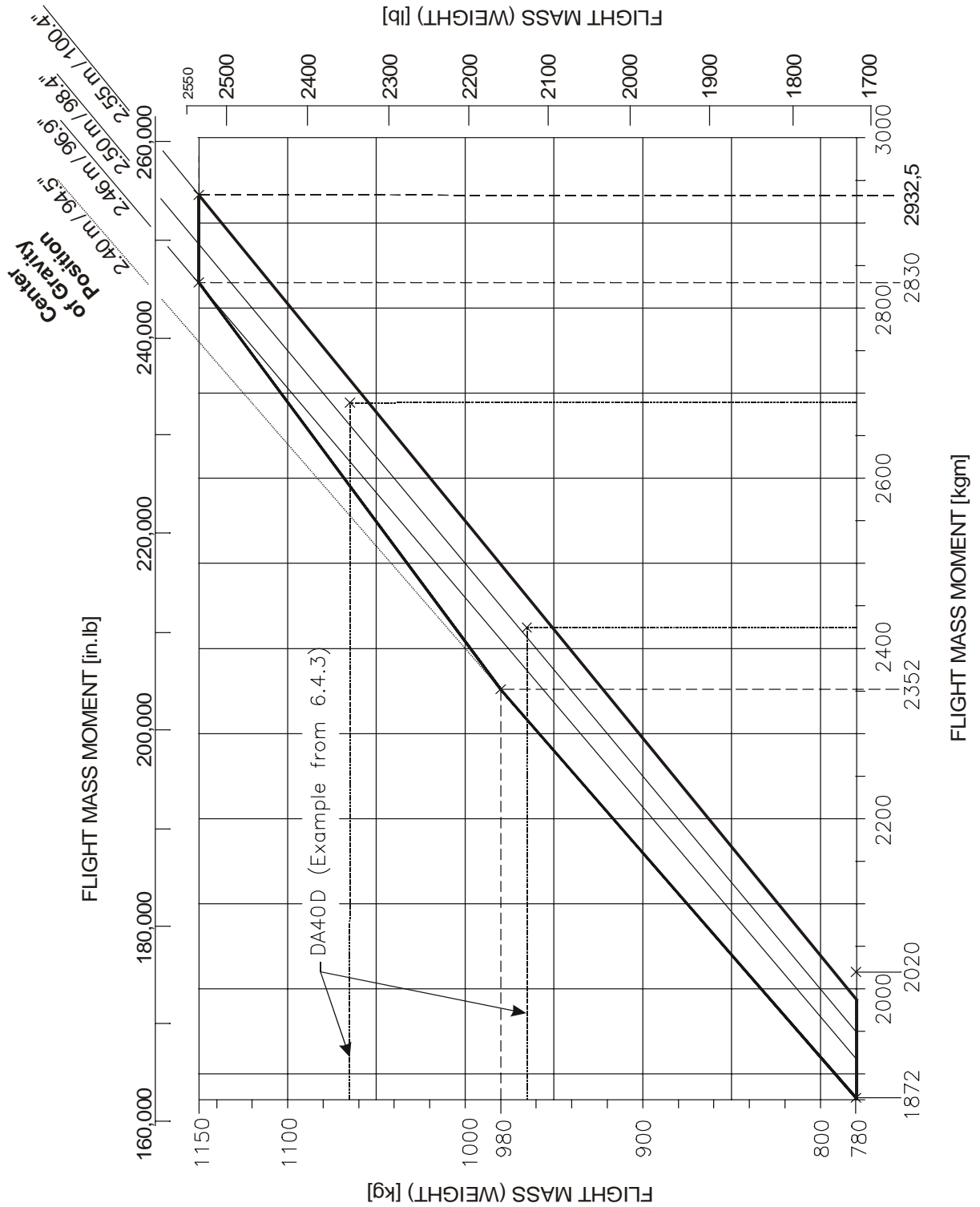

## 6.5 EQUIPMENT LIST AND EQUIPMENT INVENTORY

All equipment that is approved for installation in the DA 40 D is shown in the *Equipment List* below.

The items of equipment installed in your particular airplane are indicated in the appropriate column. The set of items marked as 'installed' constitutes the *Equipment Inventory*.

### NOTE

The equipment listed below cannot be installed in any arbitrary combination. The airplane manufacturer must be contacted before removing or installing equipment, with the exception of replacing a unit by an identical unit.

Airplane Serial No.:		Registration:		Date:	
Description	Type	Part No.	Manufacturer	S/N	in- stalled
AVIONICS COOLING					
Avionics Cooling Fan	ACF314	ACF314	Sandia Aerospace		
Avionics Cooling Fan	SAFE 328	305-467-00	Sandia Aerospace		
PFD Cooling Fan	SAFE 128	305-468-00	Sandia Aerospace		
MFD Cooling Fan	SAFE 128	305-468-00	Sandia Aerospace		
Avionics Cooling Fan	Cyclon 21-3 Port	CRB6457	Lone Star Aviation		
COMMUNICATION					
COMM 1 antenna	DMC63-1/A		DM		
COMM 2 antenna	DMC63-2		DM		
COMM #1	GNS 430	011-00280-10	Garmin		
COMM #1	GNS 530	011-00550-10	Garmin		
COMM #2	GNS 430	011-00280-10	Garmin		
Audio Panel / Marker / ICS	GMA 340	011-00401-10	Garmin		
ICS	PM1000 II	11922	PS Engineering		
Headset, pilot	Echelon 100		Telex		
Headset, copilot	Echelon 100		Telex		
Headset, RH pax	Echelon 100		Telex		
Headset, LH pax	Echelon 100		Telex		
Speaker	FRS8 /4 Ohms		Visaton		
Handmic	100TRA	62800-001	Telex		

Airplane Serial No.:		Registration:		Date:	
Description	Type	Part No.	Manufacturer	S/N	in-stalled
AUTOPILOT SYSTEM:	KAP 140		Bendix/King		
Flight computer	KC 140	065-00176-5402 (prior MSB40-018)	Bendix/King		
Flight computer	KC 140	065-00176-7702 (prior MSB40-018)	Bendix/King		
Flight computer	KC 140	065-00176-5403 (post MSB40-018)	Bendix/King		
Flight computer	KC 140	065-00176-7703 (post MSB40-018)	Bendix/King		
Flight computer	KC 140	065-00176-7904	Bendix/King		
Pitch servo	KS 270 C	065-00178-2500	Bendix/King		
Pitch servo mount	KM 275	065-00030-0000	Bendix/King		
Roll servo	KS 271 C	065-00179-0300	Bendix/King		
Roll servo mount	KM 275	065-00030-0000	Bendix/King		
Trim servo	KS 272 C	065-00180-3500	Bendix/King		
Trim servo mount	KM 277	065-00041-0000	Bendix/King		
Configuration module	KCM 100	071-00073-5000	Bendix/King		
Sonalert	SC	SC 628	Mallory		
Control stick		DA4-2213-12-90	DAI		
CWS switch		031-00514-0000	Bendix/King		
AP-Disc switch		031-00428-0000	Bendix/King		
Trim switch assy		200-09187-0000	Bendix/King		
ELECTRICAL POWER					
Main Battery	G-35		Gill		
Backup Battery	SLA Battery	LC-RA1212P	Panasonic		
Alternator Excitation Battery	SLA Battery	LC-R121R3P	Panasonic		
External Power Connector			DAI		
Voltage Converter	RB-125	RB125-BP31	KGS Electronics		
Emergency Battery (28 pcs.)	MN 1500 AA		Duracell		
Emergency Battery		D4D-2560-92-00	Excell Battery		
ECU Backup Battery tester		500690	Krutz		
DC/AC Inverter	MD 26	MD 26-14	Mid Continent		
Voltage Converter	RH28		KGS Electronics		
EQUIPMENT					
Safety belts, pilot		5-01-1C0701-LH	Schroth		
Safety belts, co-pilot		5-01-1C5701-RH	Schroth		
Safety belts, RH pax		5-01-1B0701-RH	Schroth		
Safety belts, LH pax		5-01-1B5701-LH	Schroth		
ELT unit		E-01	ACK		
ELT remote unit		E0105	ACK		
ELT antenna		E0109	ACK		



Airplane Serial No.:		Registration:		Date:	
Description	Type	Part No.	Manufacturer	S/N	in- stalled
ELT unit	JE2-NG	JE2-1978-1NG	Jolliet Electronique		
ELT remote unit		JE2-1978-16	Jolliet Electronique		
ELT antenna		JE2-1978-73	Jolliet Electronique		
ELT unit	C406-1	453-5002-( ) <sup>2</sup>	Artex		
ELT remote switch		345-6196-04	Artex		
ELT antenna		110-338	Artex		
Buzzer		130-4004	Artex		
ELT unit	ME 406	453-6603	Artex		
ELT Buzzer		452-6505	Artex		
Arm rest from semi hard integral foam		DA4-5210-50-91	DAI		
Winter Baffle		DA4-2157-00-00	DAI		
Nose Gear Tie-down		DA4-1001-00-00	DAI		
FLIGHT CONTROLS					
Stall horn		DAI-9031-00-00	DAI		
Flaps control unit (inst. panel)		500510	Krutz		
Flaps actuator assy		500535	Krutz		
SAFETY EQUIPMENT					
Fire extinguisher, portable		HAL1	AIR Total		
Fire extinguisher, portable <sup>3</sup>		A 620 T	Amerex		
First aid kit					
FUEL					
Fuel transfer pump		1168941	Dukes Inc.		
HYDRAULIC					
Master cylinder		10-54A	Cleveland		
Parking valve		60-5B	Cleveland		
Brake assembly		30-239A	Cleveland		
INDICATING / REC. SYSTEM					
Digital chronometer with OAT	M803		Davtron		
Flight timer		85094-12	Hobbs		
Annunciator panel		WW-IDC 002	White Wire		
Primary Flight Display (PFD)	GDU 1040	011-00972-02	Garmin		
Multi Function Display (MFD)	GDU 1040	011-00972-02	Garmin		
Primary Flight Display (PFD)	GDU 1040	011-00972-03	Garmin		
Multi Function Display (MFD)	GDU 1040	011-00972-03	Garmin		
LIGHTS					
Map/Reading light assy crew		W1461.0.010	Rivoret		
Cabin light		W1461.0.010	Rivoret		
Instr./Radio lights dimmer assy		WW-LCM 001	White Wire		
Glareshield lamp assy		DA4-3311-10-01	DAI		
Glareshield lamp assy		DA4-3311-10-02	DAI		
Glareshield light inverter		APVL314-8-3-L-18QF	Quantaflux		
Glareshield light inverter		APVL314-8-3-L-15QF	Quantaflux		

Airplane Serial No.:		Registration:		Date:	
Description	Type	Part No.	Manufacturer	S/N	in-stalled
Placards inverter		APVL314-8-3-L-5QF	Quantaflux		
Strobe/Pos. light assy LH	A600-PRD-14	01-0790006-06	Whelen		
Strobe/Pos. light assy RH	A600-PGD-14	01-0790006-04	Whelen		
Strobe light power supply LH/RH	A490ATS-CF-14/28	01-0770062-05	Whelen		
Taxi light	70346	01-0770346-00	Whelen		
Landing light	70346	01-0770346-00	Whelen		
Electroluminescent lamp	Quantaflux 1600	D4D-1131-20-05	Quantaflux		
Electroluminescent lamp	Quantaflux 1600	D4D-1131-21-07	Quantaflux		
Electroluminescent lamp	Quantaflux 1600	D4D-1131-20-08	Quantaflux		
Electroluminescent lamp	Quantaflux 1600	D4D-1131-20-09	Quantaflux		
NAVIGATION					
Pitot/Static probe, heated		DAI-9034-57-00	DAI		
P/S probe HTR fail sensor		D4D-3031-01-00	DAI		
Altimeter inHg/mbar, primary		5934PD-3	United Instr.		
Altimeter inHg/mbar, primary	LUN 1128	1128-12B8	Mikrotechna		
Altimeter inHg/mbar, secondary		5934PD-3	United Instr.		
Altimeter inHg/mbar, secondary	LUN 1128	1128-12B8	Mikrotechna		
Vertical speed indicator		7000	United Instr.		
Vertical speed indicator	LUN 1144	1144-A2B3	Mikrotechna		
Airspeed indicator		8025	United Instr.		
Airspeed indicator	LUN 1116	1116-B2B3	Mikrotechna		
Magnetic compass		C2400L4P	Airpath		
Directional gyro	4000B-31	1U262-002-42	Sigma-Tek		
Directional gyro	4000C-17	1U262-042-3	Sigma-Tek		
Attitude indicator	1100-14LK(0D)	504-0110-926	BF-Goodrich		
Attitude indicator	1100-14LK(-2D)	504-0110-927	BF-Goodrich		
Attitude indicator, secondary	1100-14LK(0D)	504-0110-926	BF-Goodrich		
Attitude indicator, secondary	1100-14LK(-2D)	504-0110-927	BF-Goodrich		
Attitude indicator	LUN 1241	1241.A4Y4W	Mikrotechna		
Attitude indicator	LUN 1241	1241.C4Y4W	Mikrotechna		
Turn coordinator w/o AP pickup	1394T100-(3Z)		Electric Gyro Corp.		
Turn coordinator	1394T100-(12RZ)		Mid Continent Instr.		
Turn coordinator <sup>4</sup>	1394T100-(12RA)		Mid Continent		
Turn coordinator	1394T100-(12RB)		Mid Continent		
Transponder	GTX 327	011-00490-00	Garmin		
Transponder	GTX 328	011-01684-00	Garmin		
Transponder	GTX 330	011-00455-00	Garmin		
XPDR antenna	KA60	071-01591-0001	Bendix/King		
XPDR antenna	KA61	071-00221-0010	Bendix/King		
Altitude digitizer	SAE5-35	305154-00	Sandia Aerospace		
NAV antenna coupler	CI507		Comant		
dual NAV/dual GS antenna coupler	CI 1125		Comant		
VOR/LOC/GS antenna	CI157P		Comant		
NAV/COM/GPS #1	GNS 430	011-00280-10	Garmin		
NAV/COM/GPS #1	GNS 530	011-00550-10	Garmin		
NAV/COM/GPS #2	GNS 430	011-00280-10	Garmin		
CDI, VOR/LOC/GS	GI 106A	013-00049-01	Garmin		

Airplane Serial No.:		Registration:		Date:	
Description	Type	Part No.	Manufacturer	S/N	in- stalled
CDI, VOR/LOC/GS #2	GI 106A	013-00049-01	Garmin		
GPS antenna	GA 56	011-00134-00	Garmin		
GPS antenna #2	GA 56	011-00134-00	Garmin		
GPS annunciation	MD41-1484		Mid Continent		
Compass system C/O	KCS 55A		Bendix/King		
Slave gyro	KG 102 A	060-00015-0000	Bendix/King		
HSI	KI 525A	066-03046-0007	Bendix/King		
Slaving unit	KA 51B	071-01242-0000	Bendix/King		
Flux valve	KMT 112	071-01052-0000	Bendix/King		
Marker antenna	CI102		Comant		
DME	KN 62A	066-01068-0004	Bendix/King		
DME antenna	KA60	071-01174-0000	Bendix/King		
DME antenna	KA61	071-00221-0010	Bendix/King		
ADF	KR87	066-01072-0004	Bendix/King		
ADF antenna	KA44B	071-01234-0000	Bendix/King		
ADF indicator	KI227	066-03063-0001	Bendix/King		
Stormscope	WX-500	805-11500-001	Goodrich		
Stormscope Antenna	NY-163	805-10930-001	Goodrich		
Audio Panel / Marker / ICS	GMA 1347	011-00809-00	Garmin		
Backup Altimeter		5934-PD3	United Instruments		
Backup Airspeed Indicator	8025	8025-B.833	United Instruments		
Backup Artificial Horizon	4300	4300-206	Mid Continent		
Emergency compass	PG2	PG2C-14V	SIRS Navigation		
OAT Probe	GTP 59	011-00978-00	Garmin		
Digital Air Data System	GDC 74A	011-00882-00	Garmin		
Integrated Avionics #1	GIA 63	011-00781-01	Garmin		
Integrated Avionics #2	GIA 63	011-00781-01	Garmin		
Transponder	GTX 33	011-00779-10	Garmin		
Attitude / Heading Reference System	GRS 77	011-00868-00	Garmin		
Attitude / Heading Reference System	GRS 77	011-00868-10	Garmin		
Magnetometer	GMU 44	011-00870-00	Garmin		
ADF Receiver	RA 3502-(01)	0505.757-912	Becker		
ADF/RMI Converter	AC 3504-(01)	0856.010-912	Becker		
ADF Antenna	AN 3500	0832.601-912	Becker		
DME	KN 63	066-1070-01	Bendix/King		
VACUUM					
Vacuum regulating valve	2H3-2		Parker		
Suction gauge		5001	Varga		
Pneumatic filter	1J7-2		Parker		
ENGINE	TAE-125-01	02-7200-14001R(*)	Thielert		
ENGINE	TAE-125-01	02-7200-14005R5	Thielert		
ENGINE	TAE-125-02-99	125-02-99-99-(0001)-(01)	Thielert		
ENGINE CONTROL UNIT	ECU	02-7610-55001R(*)	Thielert		

Airplane Serial No.:		Registration:		Date:	
Description	Type	Part No.	Manufacturer	S/N	in- stalled
ENGINE CONTROL UNIT	ECU	02-7610-55180R(*)	Thielert		
ENGINE CONTROL UNIT	ECU	02-7610-E000101 <sup>5</sup>	Thielert		
	ECU	05-7610-E0001 02 <sup>6</sup>	Thielert		
	ECU Firmware TAE-125 m2.3	02-7610-55-101R4	Thielert		
	ECU Mapping S14V230DIA	50-7610-55-105R3	Thielert		
	ECU Firmware TAE-125 m2.7	02-7610-55-101R7	Thielert		
	ECU Mapping T14V270DIA	50-7610-55-105R7	Thielert		
	ECU Mapping O14V271DA40	50-7610-E000101 <sup>6</sup>	Thielert		
	ECU Mapping O14V272DA40	50-7610-E000102 <sup>6</sup>	Thielert		
	ECU Mapping O14V273DA40	50-7610-E000103 <sup>6</sup>	Thielert		
ENGINE EXHAUST					
Exhaust pipe		600400	DAI		
Muffler	TTE4/53	601530	DAI		
ENGINE INDICATING					
Compact Engine Display	CED-125	02-7730-5501-(01)-(01)	Thielert		
Compact Engine Display	TAE-CED-125	02-7730-5501-(06)-(02) <sup>6</sup>	Thielert		
Auxiliary Engine Display	AED-125	02-7730-5503-(01)-(01)	Thielert		
Auxiliary Engine Display	AED-125	02-7730-5503-(02)-(02)	Thielert		
Engine / Airframe Unit	GEA 71	011-00831-00	Garmin		
PROPELLER	MTV-6-A/187-129		mt-Propeller		
LANDING GEAR					
BFW Speed ZSB		D41-3229-00-00	DAI		
Main Landing Gear SPK LH Inst.		D4-3219-01-00	DAI		
Main Landing Gear SPK RH Inst.		D4-3219-02-00	DAI		
MLG Wheel Fairing Inst.		DA4-3215-00-00	DAI		
NLG Wheel Fairing Inst.		DA4-3225-00-00	DAI		
NLG Strut Fairing Inst.		DA4-3227-00-00	DAI		
AIRPLANE FLIGHT MANUAL		Doc. No 6.01.05-E	DAI		
TANK SYSTEM					
Standard Tank <sup>1</sup>	60.021		DAI		
Long Range Tank <sup>1</sup>	60.0225		DAI		

(\*).....Mod. Status

- 1. One of the following tanks may be installed:  
Standard Tank (OÄM 40-100) or Long Range Tank (OÄM 40-130).
- 2. The complete Part Number of the ELT unit depends on the registration of the airplane in which the ELT is installed.
- 3. Amerex A620T is UL approved and can be used in airplanes registered in Canada and in the USA. For airplanes registered in other countries, contact the local airworthiness authority.
- 4. The turn coordinator 1394T100-(12RA) can only be installed in conjunction with the Garmin G1000 System.
- 5. On replacement the ECU P/N 02-7610-E000101 must be replaced by ECU P/N 02-7610-E000102.
- 6. For TAE 125-02-99 engine only (if MÄM 40-256 is carried out).

Place: \_\_\_\_\_ Date: \_\_\_\_\_ Signature: \_\_\_\_\_

Intentionally left blank.

## CHAPTER 7

# DESCRIPTION OF THE AIRPLANE AND ITS SYSTEMS

7.1	INTRODUCTION .....	7-2
7.2	AIRFRAME .....	7-2
7.3	FLIGHT CONTROLS .....	7-3
7.4	INSTRUMENT PANEL .....	7-8
7.5	LANDING GEAR .....	7-11
7.6	SEATS AND SAFETY HARNESSSES .....	7-13
7.7	BAGGAGE COMPARTMENT .....	7-13
7.8	CANOPY, REAR DOOR, AND CABIN INTERIOR .....	7-14
7.9	POWER PLANT .....	7-16
	7.9.1 ENGINE, GENERAL .....	7-16
	7.9.2 OPERATING CONTROLS .....	7-17
	7.9.3 PROPELLER .....	7-21
	7.9.4 ENGINE INSTRUMENTS .....	7-23
	7.9.5 FUEL SYSTEM .....	7-25
	7.9.6 COOLING SYSTEM .....	7-34
	7.9.7 TURBOCHARGER SYSTEM .....	7-35
	7.9.8 OIL SYSTEMS .....	7-36
7.10	ELECTRICAL SYSTEM .....	7-37
	7.10.1 GENERAL .....	7-38
	7.10.2 ENGINE CONTROL UNIT / ECU .....	7-44
	7.10.3 ANNUNCIATOR PANEL (WARNING, CAUTION AND STATUS LIGHTS) .....	7-46
7.11	PITOT-STATIC SYSTEM .....	7-50
7.12	STALL WARNING SYSTEM .....	7-50
7.13	AVIONICS .....	7-50

## **7.1 INTRODUCTION**

Chapter 7 contains a description of the airplane and its systems, together with operating instructions.

For details about optional equipment see Chapter 9.

## **7.2 AIRFRAME**

### Fuselage

The GFRP fuselage is of semi monocoque molded construction. The fire protection on the firewall is of a special fire-resistant matting, which is covered on the engine side by stainless steel cladding. The two main bulkheads are GFRP/CFRP items.

### Wings

The wings have a front and rear spar; each wing has a top shell and a bottom shell - a 'fail-safe' concept. The wings, as well as the ailerons and flaps, are made of GFRP/CFRP, and are principally of sandwich construction. An aluminum fuel tank is installed in each of the wings.

### Empennage

The airplane has a 'T' tail of GFRP semi monocoque construction. Both the stabilizers have twin spars and a skin with no sandwich. Rudder and elevator are of sandwich construction.



### **7.3 FLIGHT CONTROLS**

The ailerons, elevator and wing flaps are operated through control rods, while the rudder is controlled by cables. The flaps are electrically operated. Elevator forces can be balanced by a trim tab on the elevator, which is operated by a Bowden cable.

#### Ailerons

Construction: GFRP/CFRP composite sandwich.

Hinges: There are 4 hinges, which are hinge pins mounted in an aluminum bracket. They are secured in position by a roll pin. The absence of this roll pin can lead to the loss of the hinge pin and a consequent loss of flight safety.

Operation: A rod-end bearing is screwed into a steel push rod and locked by means of a jam nut which has locking varnish applied to it. Damage to this varnish can indicate a twisting and thus a change to the adjustment. The connection between the rod-end bearing and the control horn is a bolt, the nut of which is likewise sealed with locking varnish.

The aluminum control horn is attached to the aileron with 3 screws.

## Flaps

**Construction:** GFRP/CFRP composite sandwich.

**Hinges:** There are 6 hinges, which are hinge pins mounted in an aluminum bracket. They are secured in position by a roll pin. The absence of this roll pin can lead to the loss of the hinge pin and a consequent loss of flight safety. Another aluminum fitting is located at the fuselage and is attached to a torsion tube. The torsion tube is located in the fuselage, creating a connection between the left and right flaps.

**Operation:** A rod-end bearing is screwed into a steel push rod and locked by means of a jam nut which has locking varnish applied to it. Damage to this varnish can indicate a twisting and thus a change to the adjustment. The connection between the rod-end bearing and the control horn is a bolt, the nut of which is likewise sealed with locking varnish.

The flap control horn is attached to the flap with 3 screws.

The flaps are driven by an electric motor and have 3 settings:

- Cruise (UP), totally retracted
- Take-off (T/O), and
- Landing (LDG).

The flaps are operated by means of a 3-position flap selector switch on the instrument panel. The positions of the switch correspond to the positions of the flaps, the Cruise position of the switch being at the top. If the switch is moved to another position, the flaps continue to travel automatically until they have reached the position selected on the switch. The UP and LDG positions are additionally protected by a limit switch to guard against over-running the end positions.

The electrical flap drive has an automatic circuit breaker which can also be operated manually.

*Flap position indicator:*

The current flap position is indicated by means of three lights beside the flap selector switch.

When the upper light (green) is illuminated, the flaps are in the Cruise position (UP); when the center light (white) is illuminated, the flaps are in Take-off position (T/O); when the lower light (white) is illuminated, the flaps are in Landing position (LDG).

When two lights are illuminated simultaneously, the flaps are between the two indicated positions. This is the case only when the flaps are traveling.

Elevator

Construction: GFRP sandwich.

Hinges: 5 hinges.

Operation: Steel push-rods;

Two of the bellcrank bearings are accessible to visual inspection next to the lower hinge of the rudder. The elevator horn and its bearing, as well as the connection to the push-rod, can be visually inspected at the upper end of the rudder.

Rudder

Construction: GFRP sandwich.

Hinges: Upper hinge: One bolt.

Lower hinge: Bearing bracket including rudder stops, held by 4 screws to the rear web of the vertical stabilizer. The mating part on the rudder is a bracket which is attached to the rudder by 2 bolts. The bolts and nuts are accessible to visual inspection.

Operation: Steel cables, the eyes of which are connected to the bolts on the bracket.

### Elevator Trim

The trim control is a black wheel in the center console to the rear of the power lever. To guard against over-rotating, the trim wheel incorporates a friction device. A mark on the wheel shows the take-off (T/O) position.

Turn wheel to the front = nose down

Turn wheel to the rear = nose up

### Pedal adjustment

#### **NOTE**

The pedals may only be adjusted on the ground!

The pedals are unlocked by pulling the black handle which is located behind the rear attachment.

#### *Forward adjustment:*

Whilst keeping the handle pulled, push the pedals forward with your feet. Release the handle and allow the pedals to lock into place.

#### *Rearward adjustment:*

Using the unlocking handle, pull the pedals back to the desired position. Release the handle and push the pedals forward with your feet until they lock into place.

## 7.4 INSTRUMENT PANEL

### Instrument Panel Variants

The DA 40 D can be equipped with one of numerous instrument panel variants. Therefore only two example variants (VFR, IFR) are described in this section. The equipment that is actually installed in a particular airplane is listed in the Equipment Inventory in Section 6.5. The airplane manufacturer must be contacted before removing or installing equipment, with the exception of replacing a unit by an identical unit.

<b>Major instruments and controls</b>	
1 Electric Master switch	22 Intercom
2 Engine Master switch	23 COM / NAV / GPS
3 Electrical switches	24 ELT control unit
4 ECU Test button	25 Compact Engine Display (CED)
5 ECU Swap switch	26 Auxiliary Engine Display (AED)
6 Rotary buttons for instrument lighting and flood light	27 Transponder
7 Flap selector switch	28 Stall warning horn
8 Microphone socket	29 Directional gyro
9 Circuit breakers*	30 Autopilot control unit
10 Accessory power socket	31 Emergency switch
11 Alternate static valve	32 Slaving meter
12 Ventilation nozzles	33 Horizontal situation indicator (HSI)
13 Chronometer with OAT indicator	34 GPS annunciation unit
14 Turn & bank indicator	35 ADF indicator
15 Airspeed indicator	36 COM / NAV / GPS No. 2
16 Suction gauge	37 DME
17 Attitude gyro (artificial horizon)	38 ADF receiver
18 Altimeter	39 Remote DME switch
19 Vertical speed indicator (VSI)	40 'ECU Backup Unsafe' light
20 Annunciator panel	41 'Clear WX 500' button
21 Course deviation indicator (CDI)	

\*) Designations and abbreviations used to identify the circuit breakers are explained in Section 1.5 - DEFINITIONS AND ABBREVIATIONS of the AFM.

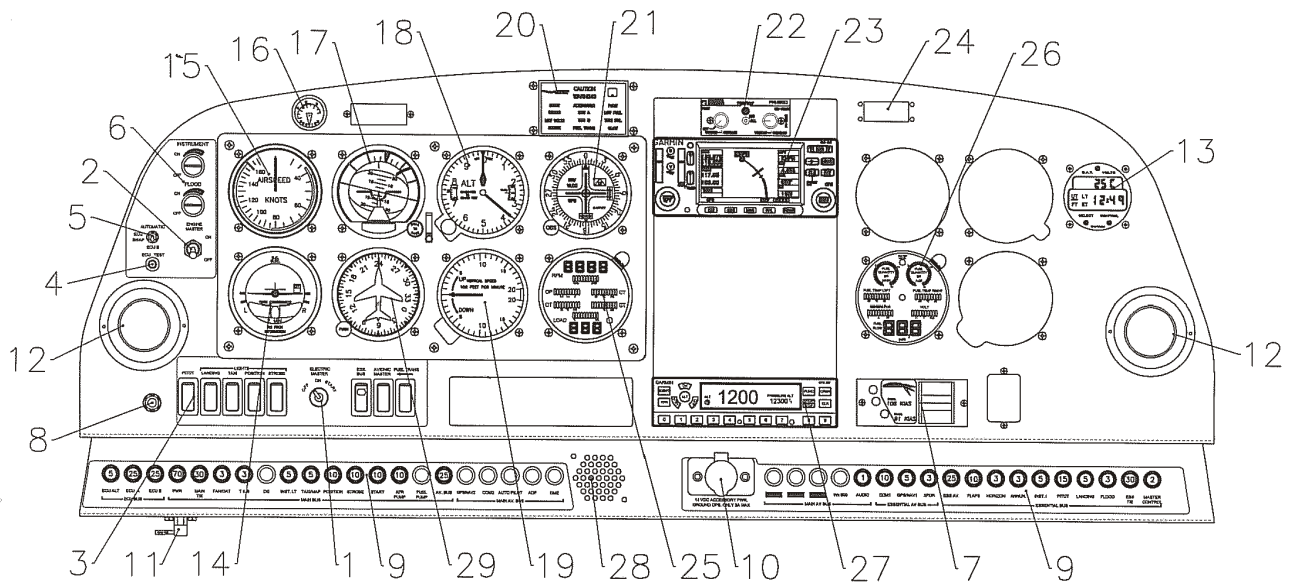

VFR instrument panel (example)

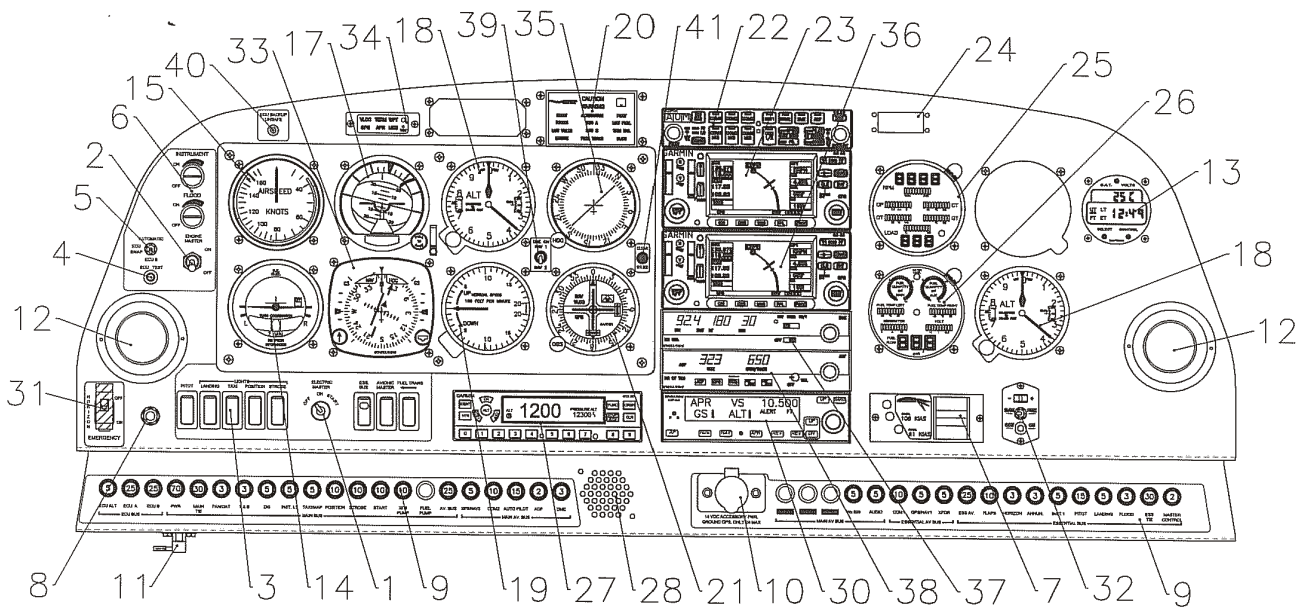

IFR instrument panel (example)

Cockpit ventilation

Ventilation in the front is provided by the movable ventilation over nozzles (12) in the instrument panel. Furthermore there are spherical nozzles in the roll bar on the left and right side next to the front seats as well as on the central console above the passengers' heads. The spherical nozzles are opened and closed by twisting.

The figures below show the position of the panel mounted switch of the ELT, ARTEX C406-1 or ME 406, which are applicable for all instrument panel versions of the DA 40 D, except the Garmin G1000 variant.

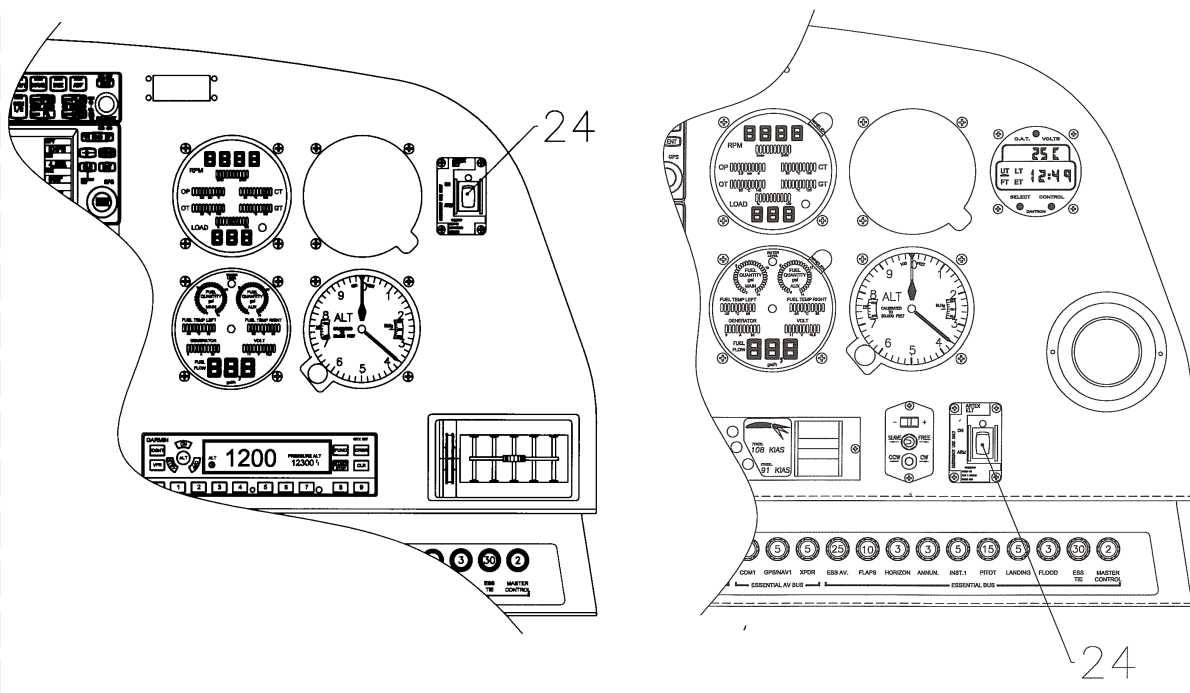



## **7.5 LANDING GEAR**

The landing gear consists of a main landing gear of sprung steel struts, and a free-castering nose wheel which is sprung by an elastomer package.

The wheel fairings are removable. When flying without wheel fairings, it should be noted that there is a reduction in some areas of performance (see Chapter 5).

### Wheel brakes

Hydraulically operating disk brakes act on the wheels of the main landing gear. The wheel brakes are individually operated by means of toe pedals.

### Parking brake

The lever is located on the small center console under the instrument panel, and is in the upper position when the brakes are released. To operate the parking brake pull the lever downwards until it catches. Brake pressure is built up by multiple operation of the toe brake pedals, and is maintained until the parking brake is released. To release, the lever is pushed upwards.

Hydraulic system schematic

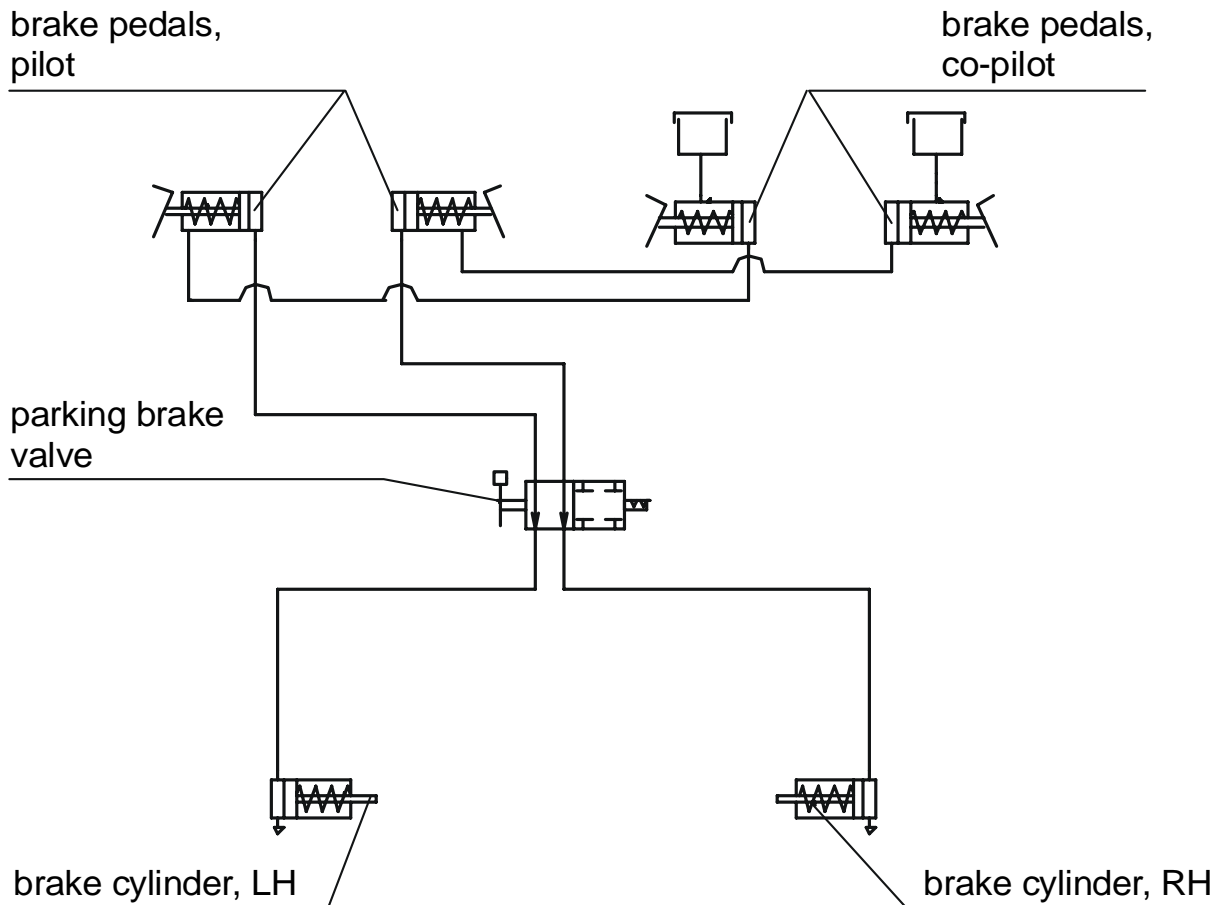

## **7.6 SEATS AND SAFETY HARNESSSES**

To increase passive safety, the seats are constructed using a carbon fiber/Kevlar hybrid material and GFRP. The seats are removable to allow the maintenance and inspection of the underlying controls. Covers on the control sticks prevent loose objects from falling into the area of the controls.

The seats have removable furnishings and are equipped with energy-absorbing foam elements.

The seats are fitted with three-part safety harnesses. The harnesses are fastened by inserting the end of the belts in the belt lock, and are opened by pressing the red release on the belt lock.

The backs of the rear seats can be laid forward after pulling upwards on the knob of the locking bolt.

## **7.7 BAGGAGE COMPARTMENT**

The baggage compartment is behind the seat backs of the rear seats. Without a baggage net, no baggage may be loaded.

## **7.8 CANOPY, REAR DOOR, AND CABIN INTERIOR**

### Front canopy

The front canopy is closed by pulling down on the canopy frame, following which it is locked by means of a handle on the left hand side of the frame. On locking, steel bolts lock into mating holes in polyethylene blocks.

"Cooling Gap" position: A second setting allows the bolts to lock in, leaving a gap under the forward canopy.

The canopy can be blocked by a locking device on the left side near the canopy opening lever by turning the key clockwise. The closed and blocked canopy can be opened from inside by pulling the lever inside the opening handle.

### **WARNING**

The airplane may be operated with the front canopy in the "cooling gap" position on the ground only. Before take-off the front canopy must be completely closed and locked.

Do not block the front canopy with the locking key before flight in order to assure emergency evacuation from outside.

A window on the left and right hand side of the canopy can be opened for additional ventilation or as an emergency window.

### Rear door

The rear door is closed in the same way, by pulling down on the frame and locking it with the handle. A gas pressure damper prevents the door from dropping; in strong winds the assembly must be held. The rear door is protected against unintentional opening by an additional lever.

The door can be blocked by a locking device on the left side near the door opening lever by turning the key clockwise. The closed and blocked door can be opened from inside by pulling the lever inside the opening handle. For a better handling an additional handle is mounted.

### **WARNING**

Do not block the door with the locking key before flight in order to assure emergency evacuation from outside.

### Heating and ventilation

Heating and ventilation are operated using two levers located on the small center console under the instrument panel.

Left lever:                      up        = heating ON  
   down      = heating OFF

Central lever:                    up        = airflow to canopy (DEFROST)  
(air distribution lever)        down      = airflow to floor (FLOOR)

## 7.9 POWER PLANT

### 7.9.1 ENGINE, GENERAL

Thielert Aircraft Engines TAE125:

- Liquid-cooled four-stroke Diesel-cycle engine with wet sump lubrication
- In-line construction
- Common-rail direct injection
- Propeller speed-reducing gear 1:1.69
- Digital Engine Control with Integrated Propeller Governor (separate oil system)
- Turbocharger with Intercooler

Displacement:

■ TAE 125-01:	1689 cm <sup>3</sup> (103 in <sup>3</sup> )
■ TAE 125-02-99:	1991 cm <sup>3</sup> (121.5 in <sup>3</sup> )

Max. power: 99 kW (135 DIN-HP) at 2300 RPM at sea level and ISA

Max. continuous power: 99 kW (135 DIN-HP) at 2300 RPM at sea level and ISA

The indications for monitoring important engine-parameters during operation are integrated within two instruments (CED 125; AED 125) in the right half of the instrument panel. The engine can only be operated with the ENGINE MASTER switch ON. The ECU receives its electrical power from the battery even if the battery is disconnected from the electric power distribution system by the ELECTRIC MASTER switch.

## 7.9.2 OPERATING CONTROLS

### Power lever

The engine performance is controlled by the power lever, situated on the large center console. 'Front' and 'rear' are defined in relation to the direction of flight. Friction can be adjusted by pulling up the friction handle (high friction) or pressing the button (low friction) on top of the lever.

This lever is used to set the desired engine power LOAD (%)

Lever forward (MAX) = Full power

Lever to rear (IDLE) = Idle

The ECU controls manifold pressure, injected fuel quantity and propeller speed according to the desired engine power preselected with the power lever.

The propeller governor is flanged onto the front of the engine. The propeller governor oil circulation is a separate oil circulation system. Following a loss of oil pressure the blades go to the finest possible pitch (maximum RPM), thus allowing continuation of the flight according to 3.2.6 - DEFECTIVE RPM REGULATING SYSTEM.

### **CAUTION**

Following governor failure the RPM should be adjusted using the power lever. Every effort should be made not to exceed 2500 RPM.

### **CAUTION**

The power lever should be moved slowly, in order to avoid over-speeding and excessively rapid RPM changes. The light wooden propeller blades produce more rapid RPM changes than metal blades.

## WARNING

It is possible that the propeller blades remain in the position of highest pitch in case of a malfunction of the engine control unit. In this case the reduced engine performance should be taken into consideration.

### ELECTRIC MASTER

The key can be switched into three positions:

- OFF**            disconnecting battery power
- ON**             connecting battery power to the power distribution system
- START**        starting the engine

### ENGINE MASTER

The engine can only be cranked with the ENGINE MASTER switched to ON. To shut down the engine the ENGINE MASTER is switched to OFF.

### ECU SWAP

For normal operation this switch is set to AUTOMATIC. The engine is controlled by ECU A. In case of a failure of the active engine control unit (ECU) there should be an automatic switch-over to the ECU B. If the automatic switch-over fails, switch-over can be done manually by switching to ECU B. This procedure should only be applied in an emergency.



## ECU TEST

Depending on the position of the power lever and the engine speed, the ECU TEST button has two different functions.

*Power lever at IDLE and RPM below approximately 900:*

By pushing and holding the button until the end of the procedure, the self-test of the engine control unit is started. The procedure is possible on the ground as well as during flight, but only if the power lever is in the IDLE position. Otherwise the test will not start. During the procedure the ECU performs a switch from ECU A to ECU B with the propeller cycling. The propeller RPM is monitored automatically by the ECU. When switching from one ECU to the other, a slight shake of the engine may occur. Finally the ECU switches back from ECU B to ECU A. After that both caution lights must extinguish and the engine must run without a change.

*Power lever above IDLE, or RPM above approximately 900:*

If an ECU A or ECU B caution message is displayed, the ECU TEST button can be pressed for more than 2 seconds to reset the message. The reset is possible only once, and only in case of system faults of minor criticality.

In addition, the 'ECU Test'-button is used in IFR equipped airplanes to test the ECU Backup Battery for proper charge. This test must be passed prior to each flight. The test is possible on ground as well as during flight, but only if the ECU Backup Battery is not in use. Otherwise the test will not start. During the test, a battery tester, installed in the instrument panel, measures several parameters of the ECU Backup Battery. This will be indicated with a red LED flashing, installed on the left hand side of the instrument panel. If the capacity of the ECU Backup Battery has been found to be less than 70% of its rated capacity the 'ECU BACKUP UNSAFE'- light is on continuously.

Alternate Air

In the event of power loss because of icing or blocking of the air filter, there is the possibility of drawing air from the engine compartment. The ALTERNATE AIR operating lever is located under the instrument panel to the left of the center console. To open the alternate air source the lever is pulled to the rear. Normally, the alternate air source is closed, with the lever in the forward position.

Placard on the lever, forward position:

**ALTERNATE AIR**

Placard on the lever, visible when lever is in the rearward position:

**ALTERNATE AIR  
ON**

### 7.9.3 PROPELLER

An mt-Propeller MTV-6-A/187-129 hydraulically regulated 3-bladed constant speed propeller is installed. It has wood-composite blades with fiber-reinforced plastic coating and stainless steel edge cladding; in the region of the propeller hub the leading edge is coated with adhesive PU foil. These blades combine the lowest weight whilst minimizing vibration.

#### Propeller control

The propeller pitch control system is integrated into the engine. The pitch is controlled automatically by the ECU.

Depending on the power setting the propeller pitch is adjusted so that the required RPM will be obtained as shown in the following diagram.

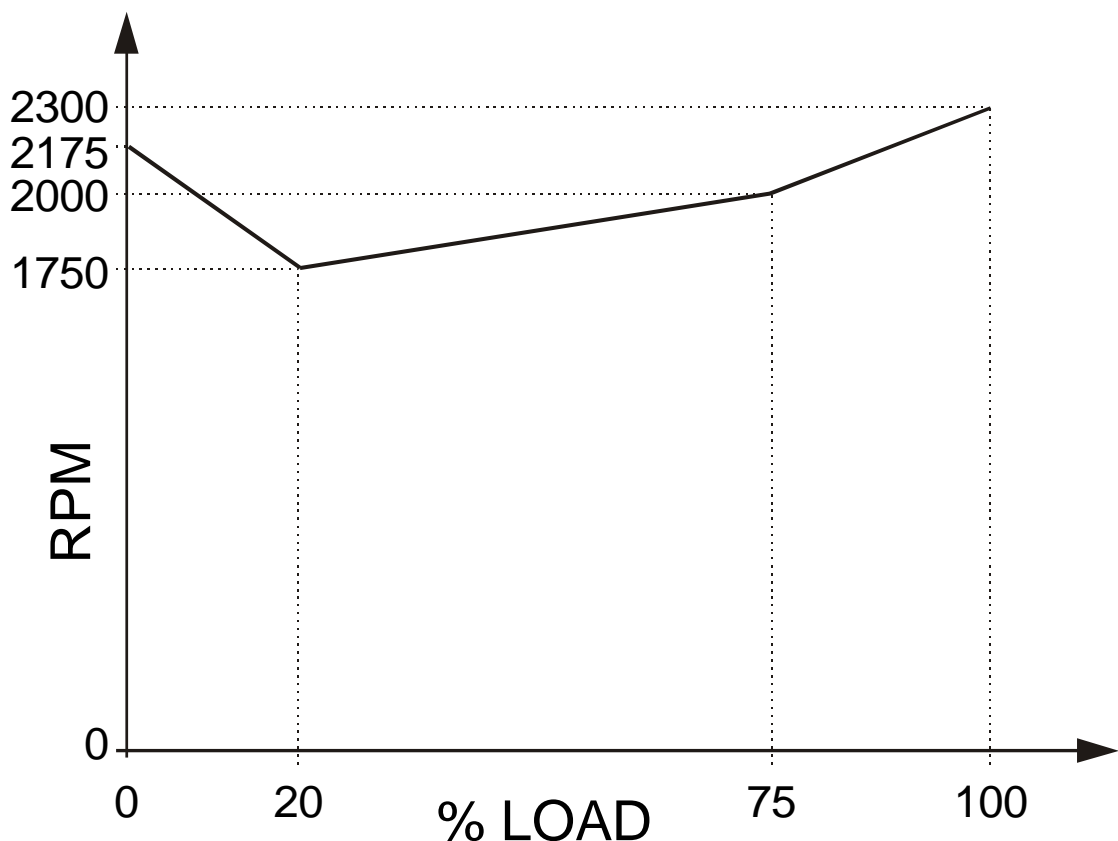

**CAUTION**

Operation on the ground at high RPM should be avoided as far as possible, as the blades could suffer stone damage. For this reason a suitable site for engine runs should be selected, where there are no loose stones or similar items.

**WARNING**

Never move the propeller by hand.

**7.9.4 ENGINE INSTRUMENTS**

Compact Engine Display (CED 125)

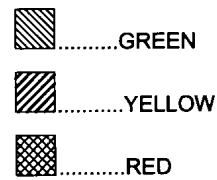
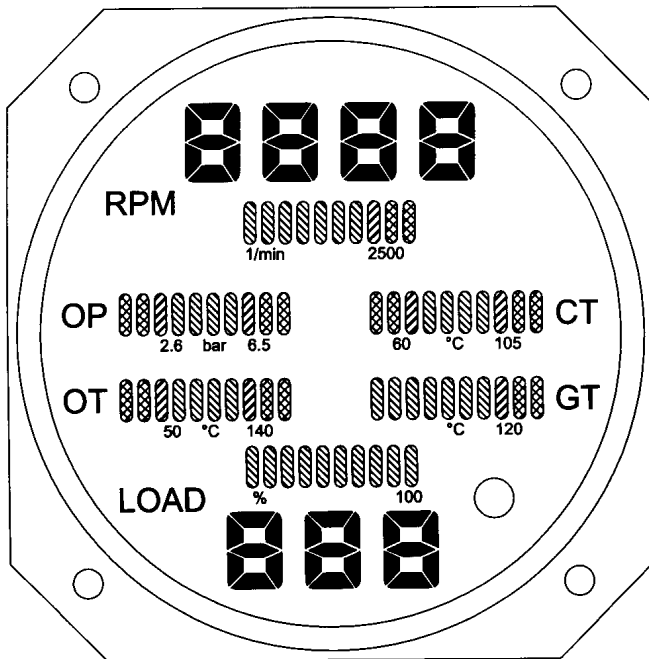

**NOTE**

Indicated values are only for general information. Exact values cannot be indicated on the CED 125.

Indications on the Engine Instrument CED 125

Designation	Indication	Unit
RPM	Propeller RPM	1/min
OP	Oil pressure	bar
OT	Engine oil temperature	°C
CT	Coolant temperature	°C
GT	Gearbox temperature	°C
LOAD	Available power	%

Auxiliary Engine Display (AED 125)

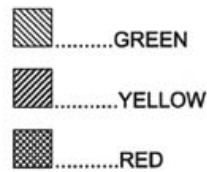
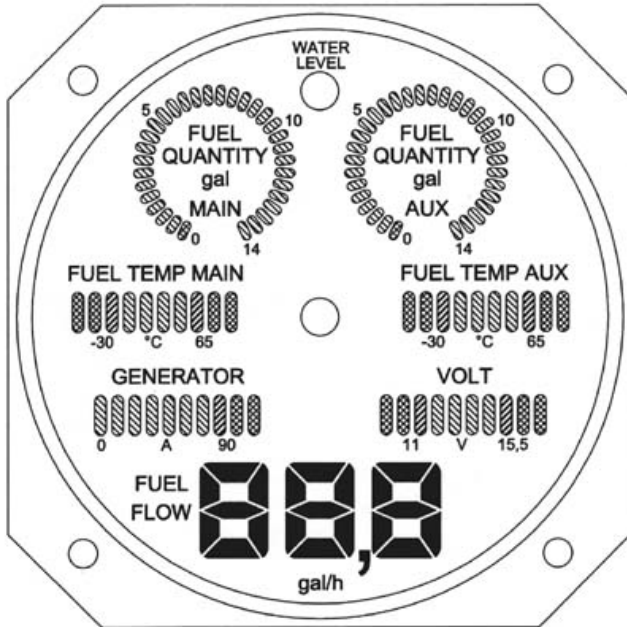



Fuel quantity:  
2 digits = appr. 1 US gal

Indications on the Auxiliary Engine Instrument AED 125

Designation	Indication	Unit
FUEL QUANTITY MAIN	Fuel quantity MAIN tank	gal
FUEL QUANTITY AUX	Fuel quantity AUX tank	gal
WATER LEVEL	Coolant level	--
FUEL TEMP. LEFT	Fuel temperature left tank	°C
FUEL TEMP. RIGHT	Fuel temperature right tank	°C
GENERATOR	Ampères	A
VOLT	Volts	V
FUEL FLOW	Fuel flow	US gal/h



**7.9.5 FUEL SYSTEM**

NORMAL FUEL SUPPLY & NORMAL FUEL TRANSFER

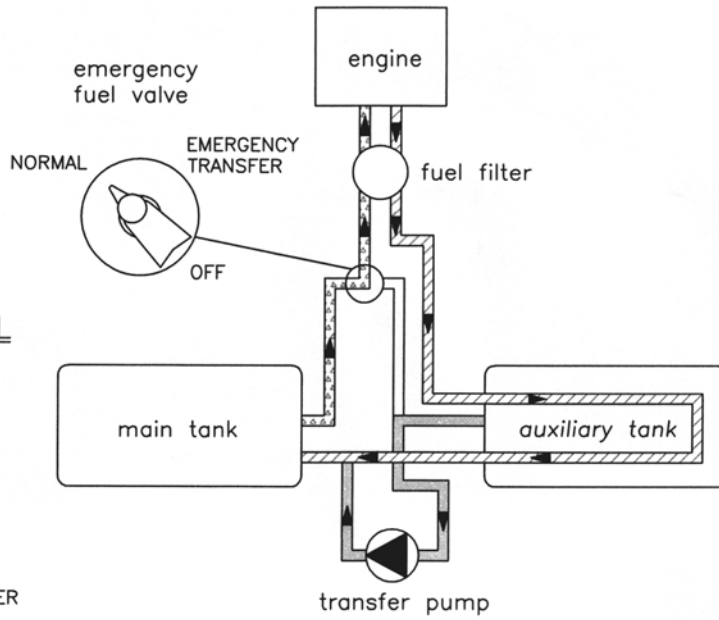
-  FUEL SUPPLY
-  FUEL RETURN
-  FUEL TRANSFER



EMERGENCY FUEL SUPPLY & EMERGENCY FUEL TRANSFER

-  EMERGENCY FUEL SUPPLY
-  EMERGENCY FUEL TRANSFER & FUEL RETURN

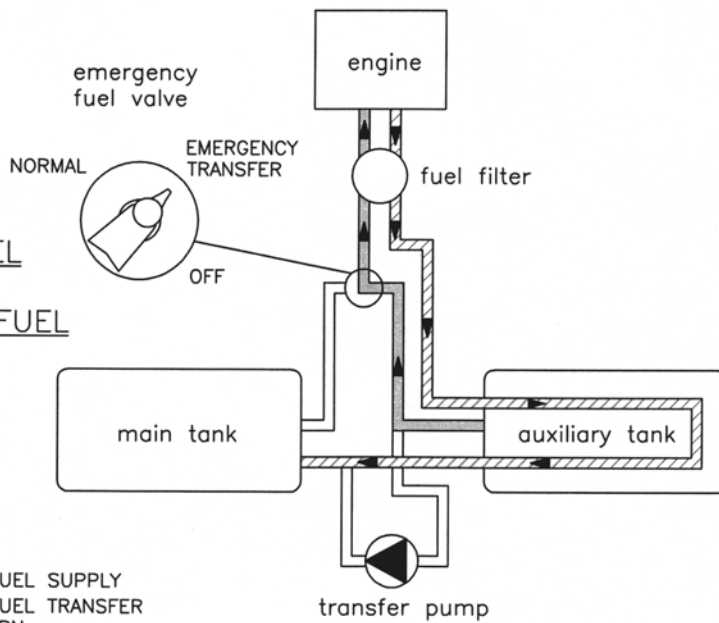

Fuel is injected with high pressure directly into the cylinders. The injection nozzles (one per cylinder) are supplied with fuel by the common rail. Pressure inside the rail is generated by a high pressure pump which receives fuel from a low pressure pump. Both pumps are powered mechanically by the engine.

Normally fuel is taken only from the MAIN tank (left wing). Fuel that is not injected is lead through the AUX tank (right wing) back into the MAIN tank (left wing). This way hot fuel from the rail is cooled and cold fuel in both tanks is heated. With the help of an electrical transfer pump fuel can be transferred from the AUX tank (right wing) to the MAIN tank (left wing) manually.

The transfer pump is switched off automatically when the auxiliary tank is empty or the main tank is full.

If fuel transfer with the transfer pump becomes impossible for any reason, fuel can also be taken directly from the AUX tank (right wing). As the return line goes back into the MAIN tank (left wing), fuel will be transferred from right to left.

The rail pressure is controlled by an electrical valve using the return flow as parameter.

### **CAUTION**

Switching the emergency fuel valve to the EMERG. TRANSFER position will start the transfer of fuel with the help of the engine driven fuel pump from the auxiliary tank through the fuel return line to the main tank at a rate of approximately 18 to 21 US gal/h (70 to 80 liters/h). The emergency fuel valve must be switched back to the NORMAL position before the auxiliary tank indication reads zero. If the emergency fuel valve is not switched back to the NORMAL position, the engine will stop during flight when the auxiliary tank is empty.



### Emergency fuel valve

The emergency fuel valve is situated on the center console. Its positions are NORMAL, EMERG. TRANSFER and OFF. The desired position is reached by turning the valve handle while pulling up the safety catch on the valve handle. This is to ensure that a selection is not made unintentionally.

### Fuel tanks

#### *Main tank (left wing):*

The main tank consists of an aluminum chamber and a filler tube which are connected by a flexible hose. There are two tank vents. One includes a check valve with a capillary and one includes a relief pressure valve, which operates at 150 mbar (2 psi) and allows fuel and air to flow to the outside with higher internal pressure. The relief pressure valve protects the tank against high pressure, if the tank will be overfilled in case of a fuel transfer failure. The check valve with capillary allows air to enter the tank but prevents flow of fuel to the outside. The capillary equalizes the air pressure during climb. The hose terminations are situated on the underside of the wing, approximately 2 meters (7 ft) from the wing tip.

#### *Auxiliary tank (right wing):*

The auxiliary tank consists of an aluminum chamber and a filler tube which are connected by a flexible hose. There are two tank vents. One includes a check valve with a capillary and one includes a capillary. The check valve with capillary allows air to enter the tank during descent but prevents flow of fuel to the outside. The capillary equalizes the air pressure during climb. The second capillary is installed for additional safety. The hose terminations are situated on the underside of the wing, approximately 2 meters (7 ft) from the wing tip.

In each tank a coarse filter (finger filter) is fitted before the outlet. To allow draining of the tank, there is an outlet valve at its lowest point.

A gascolator sits at the lowest point in the fuel system. A drain valve is fitted to the gascolator, which can be used to remove water and sediment which has collected in the fuel system. This valve is fitted centrally on the underside of the fuselage, approximately 30 cm (1 ft) forward of the wing leading edge.

A capacity probe measures the fuel quantity in each tank. The AED shows only counts. The indication is non-linear, therefore proportional calculations to determine the remaining fuel quantity or direct calculations of fuel consumption are not possible. Information about the fuel consumption can be found in Chapter 5 - PERFORMANCE.

### Long Range Tank

If the Long Range Tank is installed, the filler tube of the main and the auxiliary tank is replaced by another tank chamber. This tank chamber has a capacity of approx. 5 US gal (19 liters). The ventilation system of the main and the auxiliary tank remains unchanged.

When the fuel quantity indicator reads zero, only the unusable fuel remains in the tank. The useable capacity of each tank is 19.5 US gal, the maximum quantity that can be indicated is 15 US gal. Up to an actual quantity of 15 US gal the indication is correct. At an actual quantity above 15 US gal the indication remains at 15 US gal.

### **NOTE**

When the fuel quantity indicator reads 15 US gal, the correct fuel quantity must be determined with the alternate mean for fuel quantity indication. If this measurement is not carried out, the fuel quantity available for flight planning is 15 US gal.

**|** Fuel cooler

**|** The fuel cooler reduces the fuel temperature in the return line between the AUX tank (right wing) and the MAIN tank (left wing).

**|** The fuel cooler is installed in the right hand stub wing between the main spars. It receives its cooling air through an air scoop on the lower surface of the stub wing. This inlet is closed with a baffle which must be removed at high outside air temperatures (OAT higher than 20 °C (68 °F), see also Sections 4A.3.1 and 4B.2.6).

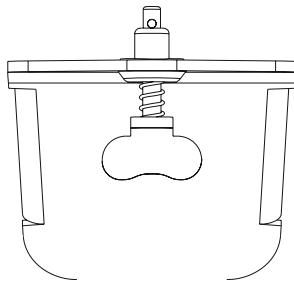
**|** Fuel cooler baffle:

Alternate mean for fuel quantity indication for the Standard Tank

The alternate mean for fuel quantity indication allows the fuel quantity in the tank to be determined during the pre-flight inspection. It functions according to the principle of communicating containers. The fuel quantity measuring device has a recess which fits the airfoil of the wing. With this recess the device is held against the stall strip at the leading edge of the wing. The exact position is marked by a bore in the stall strip. Then the metal connector is pressed against the drain of the tank. The amount of fuel in the tank can now be read off from the vertical ascending pipe.

For an exact indication the airplane must stand on a horizontal ground.

The designated place for the fuel quantity measuring device is the bag on the rear side of the pilot seat.

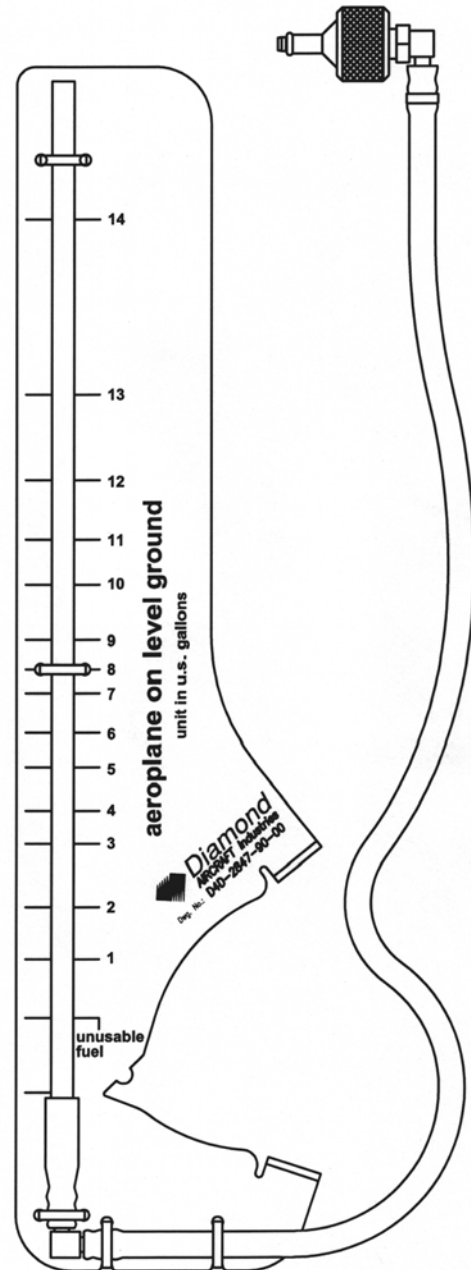

Alternate mean for fuel quantity indication for Long Range Tank

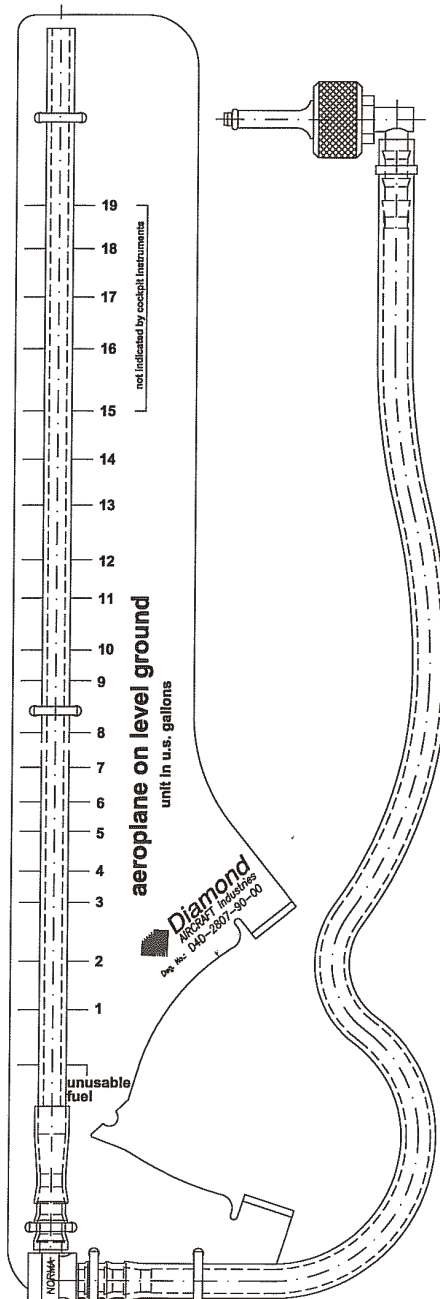

Fuel temperature

The fuel temperature is indicated by the AED. The temperature indication range goes from -30 °C up to +75 °C ( -22 °F to +167 °F) . The lower yellow bar indicates temperatures from -30 °C to +4 °C (-22 °F to +39 °F).

The lower yellow bar of the fuel temp flashes from -30 °C to -6 °C (-22 °F to +21 °F). The flashing bar indicates the temperature range in which the engine must not be started if Diesel Fuel or a blend of Diesel Fuel with JET Fuel is used. If the fuel blend is uncertain, the engine must not be started in this temperature range either.

Between -5 °C and +4 °C (+23 °F to +39 °F) the lower yellow bar of the fuel temp is continuously on. This indicates that the airplane is not ready for take-off if Diesel Fuel or a blend of Diesel Fuel with JET Fuel is used. If the fuel grade is uncertain, take-off is not allowed in this temperature range either.

If the airplane is being operated with JET Fuel, operation in the yellow temperature range (conventional instrument: flashing or steady on) is permissible.

Fuel Grades:

The airplane may be operated with JET Fuel and Diesel Fuel according to Section 2.14, and with blends of these fuel grades. As the fuel grade is important concerning operating temperature limitations, the pilot must be sure about the fuel grade. Solid particles can form in cold Diesel Fuel which can lead to blocking of the gascolator filter. The gascolator filter is not heated.

If the airplane is operated in a cold environment, it must be changed from Diesel Fuel operation to JET Fuel operation. To ensure that no blend of JET Fuel with Diesel Fuel is in one of the tanks, each tank must be refilled at least twice with more than 10.6 US gal (40 liters) of JET Fuel or 17.2 US gal (65 liters) when the long range tank is installed (OÄM 40-130). Otherwise both tanks must be drained before refueling with JET Fuel.

**NOTE**

In order to provide information about the fuel grade it is recommended to enter the fuel grade in the airplane log each time fuel is refilled.

### 7.9.6 COOLING SYSTEM

The water cooling system consists of a radiator and a bypass to this radiator. The bypass cooler is in operation when coolant temperatures are low. It therefore allows a warm-up of the engine. Upon reaching a certain temperature (approximately 80 °C) the radiator is activated by a thermostat valve. Additionally a coolant to air heat exchanger is provided for the cabin heat system. The flow through the heat exchanger is independent of the coolant temperature. An expansion tank helps to adjust the pressure in the system. The system is protected against overpressure by means of a pressure relief valve.

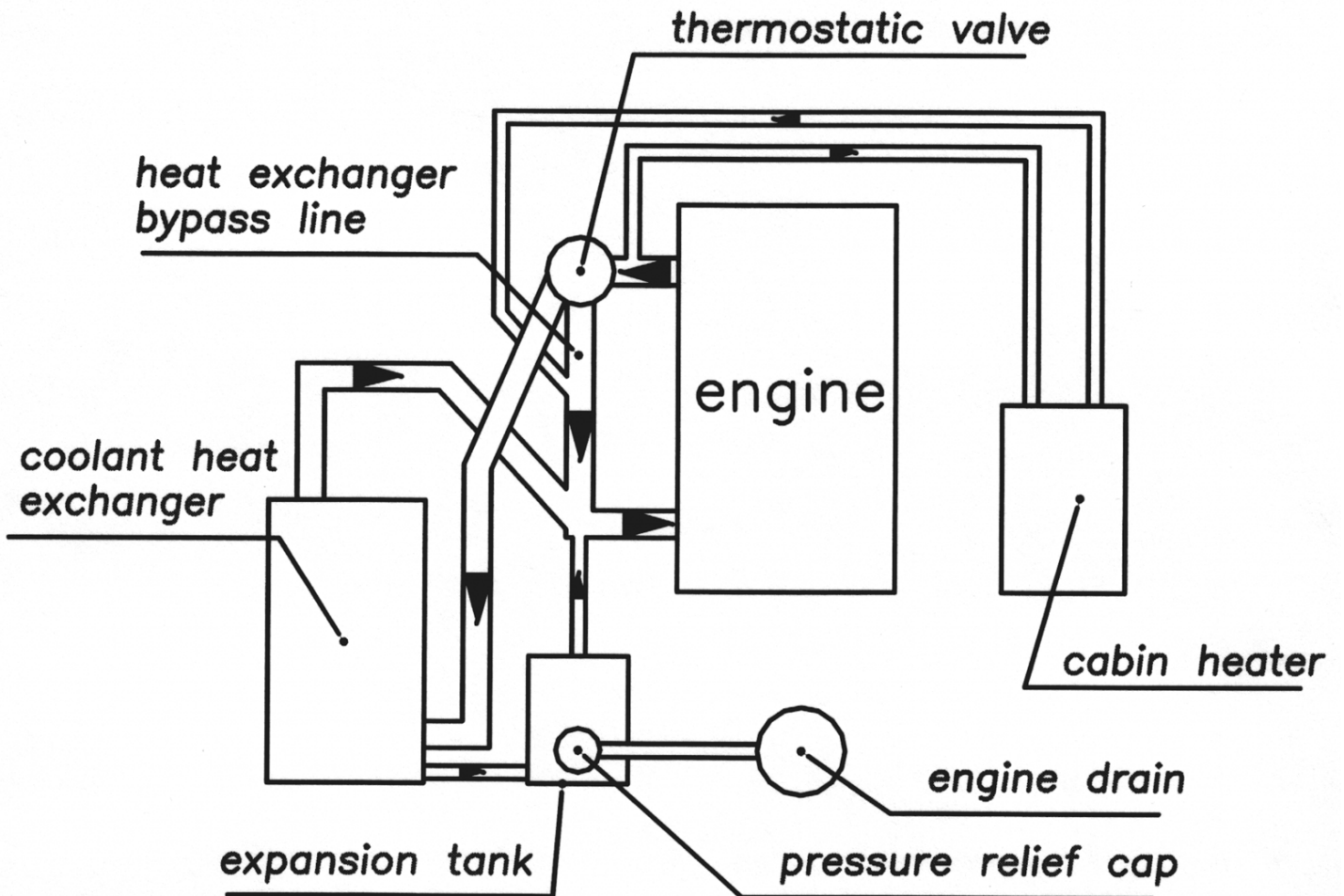



### 7.9.7 TURBOCHARGER SYSTEM

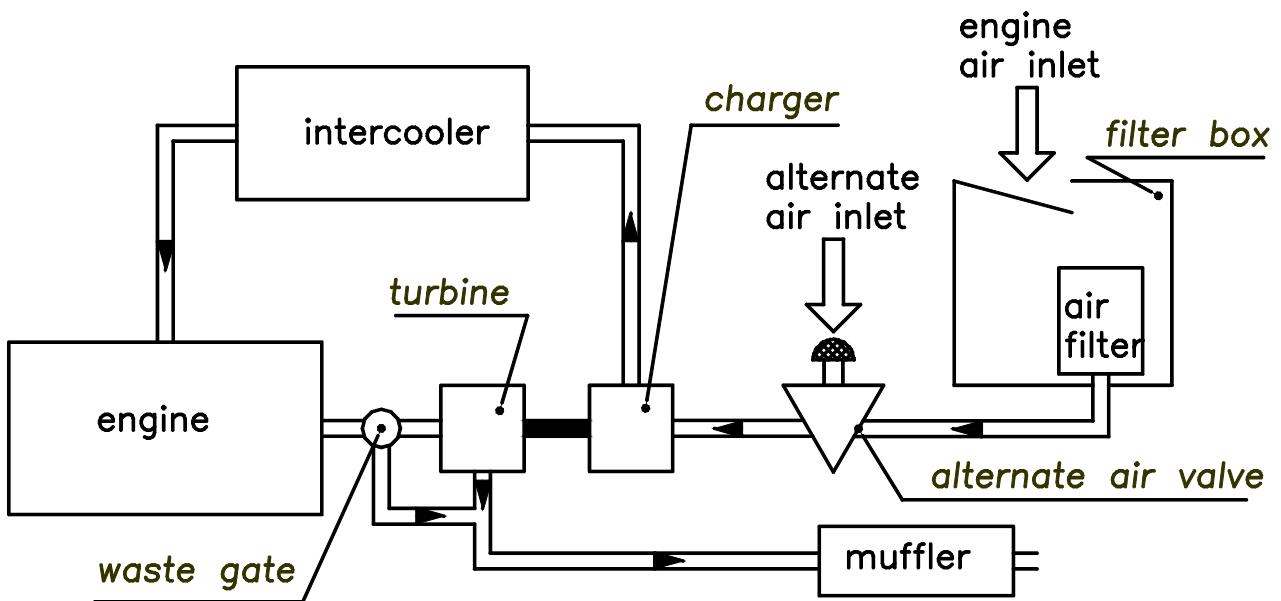

The exhaust system contains a collecting line which collects exhaust gases from the outlets of the cylinders and leads them to the turbine of the turbocharger. Behind the turbine the exhaust gases are guided through the lower cowling to the exterior of the airplane. Excess exhaust gases bypass the turbine. The bypass is controlled by the ECU through the waste gate valve. A manifold pressure sensor behind the compressor allows the ECU to calculate the correct position of the waste gate valve. This prevents too high manifold pressures at low density altitudes. The intake air is compressed in the compressor which is driven by the turbine, and afterwards cooled down in the intercooler to increase power. Cooling the air increases efficiency through the higher density of the cooler air.

### **7.9.8 OIL SYSTEMS**

The engine has two separate oil systems.

#### Lubrication system (engine and turbocharger)

The engine lubrication is a wet sump lubrication system. Oil is cooled by a separate cooler on the underside of the engine.

A dip-stick is provided to check the oil quantity through an inspection hole in the upper cowling. If required, oil can also be filled in there (for specified oil types refer to 2.4 - POWER-PLANT LIMITATIONS).

#### Gearbox and propeller governor system

The second oil circuit lubricates the gear and serves the governor system and the regulation of the propeller.

Gear oil quantity can be checked with the help of an inspection glass which can be reached through an inspection hole on the front side of the lower cowling.

### **CAUTION**

If the gear oil quantity is too low, an unscheduled maintenance is necessary (for specified oil types refer to 2.4 - POWER-PLANT LIMITATIONS).

### 7.10 ELECTRICAL SYSTEM

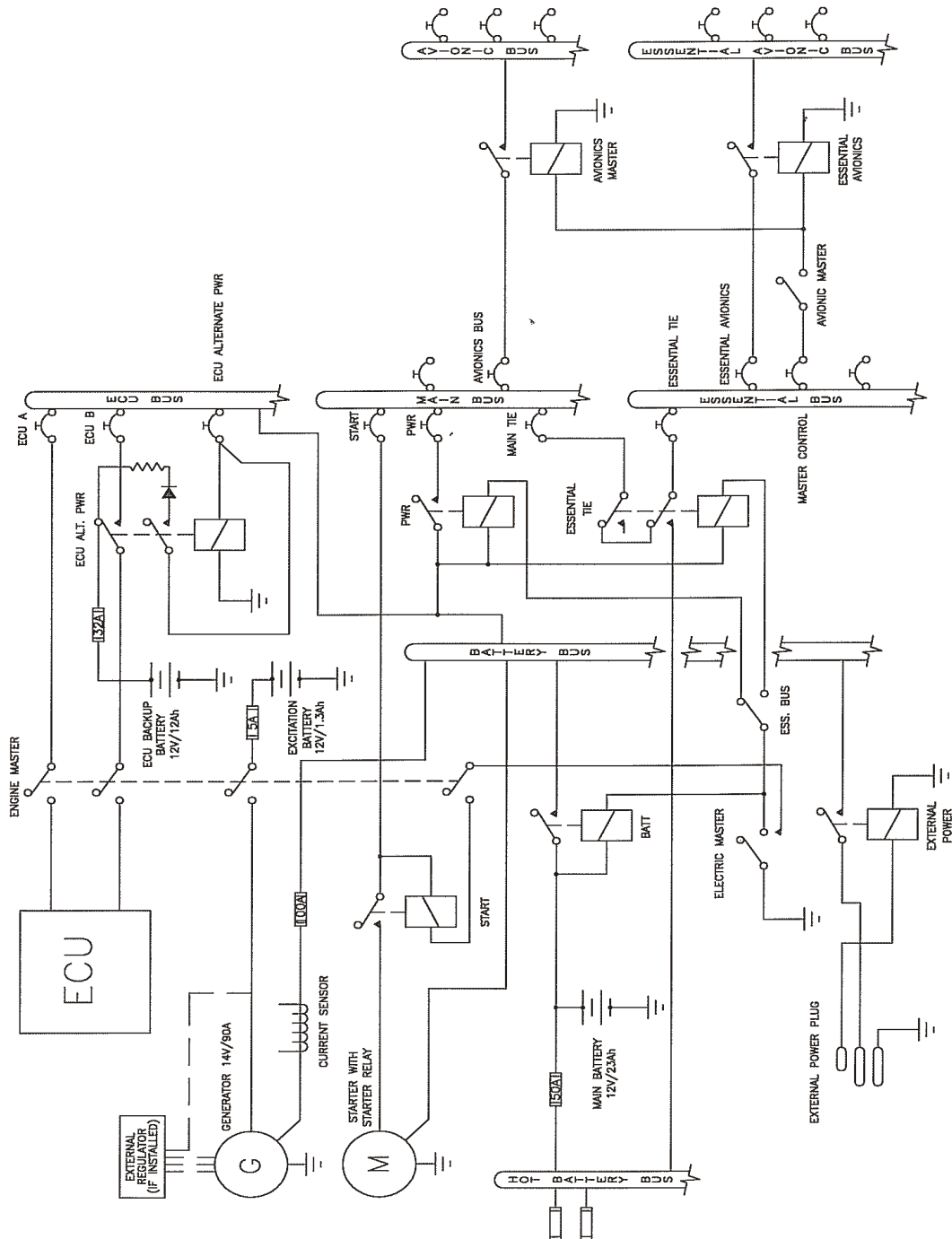

### 7.10.1 GENERAL

The DA 40 D has 12 Volt DC system, which can be sub-divided into:

- Power generation
- Storage
- Distribution
- Consumers

#### Power Generation

Power generation is provided by a 90 ampère alternator (generator) which is mounted on the bottom left side of the engine. The alternator is driven by a flat-belt.

The power output line of the alternator is connected to the 'battery bus' via a 100 A fuse, which is installed in the relay junction box mounted on the left-hand side of the firewall. The power output line also runs through the current sensor, which provides an indication of the power being supplied to the electrical system by the alternator including the current for battery charging.

■ In the event of a main battery failure the field of the alternator is energized by a 12 V, 1.3 Ah sealed-lead-acid battery ('excitation'-battery) which is installed behind the instrument panel. The 'ENGINE MASTER'-switch connects the 'excitation'-battery to the alternator field or the external voltage regulator via a 5 A fuse.

■ The alternator (P/N: 02-7150-55 002R2) has an internal voltage regulator and the alternator (P/N: 02-7150-55850R1) has an external voltage regulator which regulates the output voltage between 12 and 14 V.

### Alternator Control:

The alternator (P/N: 02-7150-55850R1) has an external alternator control unit. It measures the alternator output voltage and controls the current through the alternator field coils via a pulse-width modulated signal. To keep the output voltage stable in all load and speed situations, the alternator field signal is modulated accordingly.

The alternator control unit includes a comprehensive set of diagnostic functions that will warn the operator using a caution message (ALTERNATOR) on the Annunciator Panel in case of over- or undervoltage as well as a couple of other internal warning levels.

### Storage

'Main'-battery power is stored in a 12 V, 23 Ah lead-acid battery mounted on the right-hand side of the firewall. The 'main' battery is connected to the 'hot battery bus' via a 50 A fuse and to the 'battery bus' via the 'battery'-relay which is installed in the relay junction box on the left-hand side of the firewall.

The 'battery'-relay is controlled with the 'ELECTRIC MASTER'-key switch which is located on the left-hand side of the instrument panel.

In addition, a 12 V, 12 Ah sealed-lead-acid battery ('ECU backup'-battery) is installed under the rear right seat as a further source of power for the 'Engine Control Unit' (ECU B only).

Under normal operating conditions the 'ECU backup'-battery is charged by the 'ECU bus'. In the event of an alternator failure and a depleted 'main'-battery the 'ECU alternate power'-relay connects the 'ECU backup'-battery automatically to ECU B via a 30 A fuse. This prevents the engine from stopping in the unlikely event of an alternator failure and a totally discharged 'main'-battery.

In addition, a non-rechargeable dry battery is installed in the IFR model as a further source of power for the attitude gyro (artificial horizon) and the flood light. When the EMERGENCY switch is set to ON, these two systems are supplied with power for 1 hour, independent of all other electrical consumers. During each 100 hour inspection, this battery is checked

for proper functioning. Every 2 years or after use (broken seal on the switch) the battery cells must be replaced.

#### Distribution

Electrical power is distributed via the 'hot battery bus', the 'battery bus', the 'ECU-bus', the 'main bus', the 'essential bus', the 'avionic bus', and the 'essential avionic bus'.

#### *Hot battery bus:*

The 'hot battery bus' is directly connected to the 'main'-battery via a 50 A fuse installed in the relay junction box and cannot be disconnected from the 'main'-battery. The 'hot battery bus' provides power to the pilot map/reading light and the accessory power plug which are protected by their own fuses.

#### *Battery bus:*

The 'battery bus' is connected to the 'main'-battery via the 'battery'-relay which can be controlled by the 'ELECTRIC MASTER'-key switch. The 'battery bus' provides power to the 'ECU bus' and heavy duty power to the starter. It also provides power to the 'main bus' via the 'power'-relay which can be controlled by the 'ELECTRIC MASTER'-key switch and the 'ESSENTIAL BUS'-switch. The 'ELECTRIC MASTER'-key switch must be set to 'ON' and the 'ESSENTIAL BUS'-switch must be set to OFF to connect the 'battery bus' to the 'main bus'.

The 'battery bus' is also connected to the power output line of the alternator and the power input line of the external power plug.

#### *ECU bus:*

The 'ECU bus' is directly connected to the 'battery bus' and provides power for the ECU A and ECU B via the 'ENGINE MASTER'-switch. It also provides power for charging the 'ECU backup'-battery via the 'ECU alternate power'-relay. The 'ENGINE MASTER'-switch must be set to 'ON' to connect the ECU A and ECU B to the 'ECU bus'.

*Main bus:*

The 'main bus' is connected to the 'battery bus' via the 'power'-relay. It provides power to the consumers directly connected to the 'main bus' and the 'avionic bus' via the 'avionic master'-relay. The 'AVIONIC MASTER'-switch must be set to 'ON' to connect the 'main bus' to the 'avionic bus'. Under normal operating conditions the 'main bus' is also connected to the 'essential bus' via the 'essential tie'-relay. In the event of an alternator failure the pilot must switch ON the 'ESSENTIAL BUS'-switch (refer to Section 3.7.2 - FAILURES IN THE ELECTRICAL SYSTEM). This separates the 'main bus' from the 'battery bus' and the 'essential bus' and the equipment connected to the 'main bus' no longer has power.

*Essential bus:*

Under normal operating conditions the 'essential bus' is connected to the 'main bus' via the 'essential tie'-relay. The 'essential bus' provides power to the consumers connected to the 'essential bus' and the 'essential avionic bus' via the 'essential avionic'-relay. The 'AVIONIC MASTER'-switch must be set to 'ON' to connect the 'essential bus' to the 'essential avionic bus'. In the event of an alternator failure the pilot must switch ON the 'ESSENTIAL BUS'-switch (refer to Section 3.7.2 - FAILURES OF THE ELECTRICAL SYSTEM). This separates the 'essential bus' from the 'main bus'. The 'essential bus' is then connected to the 'hot battery bus' which provides battery power for a limited time to the equipment essential for safe flight and landing.

Consumers

The individual consumers (e.g. radio, electrical fuel transfer pump, position lights, etc.) are connected to the appropriate bus via automatic circuit breakers.

Designations and abbreviations used to identify the circuit breakers are explained in Section 1.5 - DEFINITIONS AND ABBREVIATIONS.

### Voltmeter

The voltmeter shows the voltage of the ECU bus. Under normal operating conditions the alternator voltage is shown, otherwise it is the voltage of the 'main'- or 'ECU backup'-battery, depending on which battery is currently connected to the 'ECU bus'.

- As long as the operating temperature of the alternator is not reached, it is possible that the voltage indication is in the upper yellow range. After 10 minutes of engine operation the indication should be in the green range.
- On a conventional instrument panel the ENGINE caution light illuminates, if the voltage stays in the yellow range for longer than 1 minute.

### Ammeter

The ammeter displays the intensity of current which is supplied to the electrical system by the alternator.

### Landing and taxi lights

Landing and taxi lights are built into the left wing, and are each operated by means of a switch (LANDING, TAXI) on the row of switches on the instrument panel.

### Position and strobe lights

Combined position and strobe lights (anti collision lights) are installed on both wing tips. Each system is operated by a switch (POSITION, STROBE) on the row of switches on the instrument panel.

### Flood light

A two-dimensional light emitter is mounted above the instrument panel. It illuminates the instrument panel as well as all levers, switches, etc. With a rotary button (FLOOD) in the



left-hand section of the instrument panel the flood light is switched on and its brightness is adjusted.

#### Instrument lighting

With a rotary button (INSTRUMENT) in the left-hand section of the instrument panel the internal lighting of the instruments is switched on and its brightness is adjusted.

#### Pitot heating

The Pitot probe, which provides measurement for the Pitot-static system, is electrically heated. The heating is activated with a switch (PITOT) on the row of switches on the instrument panel. The temperature is automatically kept constant by means of a thermal switch on the Pitot probe, and as an additional safety measure a thermal fuse is built in. If this thermal fuse is activated, the Pitot heating can no longer be switched on, and the Pitot heating caution will be displayed. In this case the system should be serviced. The Pitot heat caution light is also on if the Pitot heating is switched off.

## 7.10.2 ENGINE CONTROL UNIT / ECU

### Engine control and regulation

The ECU monitors, controls and regulates all important parameters for engine operation.

Sensors installed are:

- Oil temperature (lubrication system engine) / OT
- Oil pressure (lubrication system engine) / OP
- Coolant temperature / CT
- Gearbox temperature / GT
- Camshaft RPM (twice)
- Crankshaft RPM (twice)
- Fuel pressure in the common rail
- Manifold pressure
- Manifold air temperature
- Ambient air pressure
- Propeller governor / oil pressure
- Power lever position (twice)
- Voltage
- ELECTRIC MASTER signal (starter)
- Fuel pressure
- 'ECU Swap'-switch signal
- 'ECU Test'-switch signal

In accordance with the received signals and a comparison with the programmed characteristic diagrams the necessary inputs are calculated and transmitted by the following signal lines to the engine:

- Activation of starter (relay)
- Signal for propeller governor pressure valve
- Signal for the rail-pressure regulation valve
- Signal for each of the 4 injection nozzles
- Activation of the glow plugs
- Signal for the waste gate valve

The following signals are transmitted to the annunciator panel installed in the instrument panel:

- Glow sparks active
- Status ECU A
- Status ECU B

Normally the engine is controlled and regulated by the ECU A. The ECU B is a backup system to ensure redundancy. In case of an internal error during operation or the loss of a sensor signal the system automatically switches to the ECU B. If the loss of the sensor signal was the cause for the error, the system automatically switches back to ECU A.

A fault in one of the ECU's is indicated by a caution message on the annunciator panel (ECU A / ECU B). In case of minor faults, the annunciation can be reset once by pressing the ECU TEST button for more than 2 seconds. However, the annunciation will re-appear upon the next attempt to start the engine. After the indication of the ECU A/B FAIL caution message, the engine must be serviced, even if the caution message could be reset.

### 7.10.3 ANNUNCIATOR PANEL (WARNING, CAUTION AND STATUS LIGHTS)

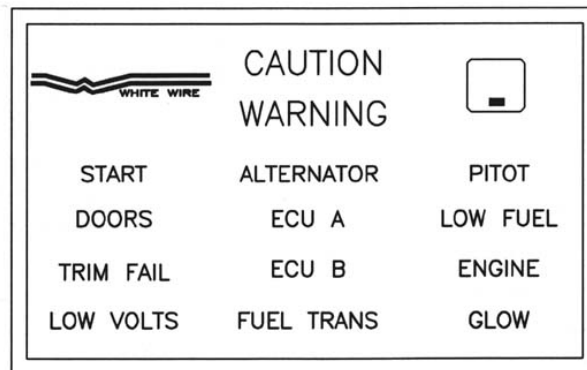

#### Testing the annunciator panel

In the process of the pre-flight check, proper functioning of the annunciator panel must be verified. This functional check is automatically started after switching the ELECTRIC MASTER to ON. All lights are flashed, and the aural alert is muted. By pressing the 'acknowledge' button, the lights are extinguished, and a momentary aural alert is sounded. This test verifies functionality of the microprocessor, the lights, and the aural signal.

The pilot may initiate additional system tests by holding the 'acknowledge' button for 2 seconds. All lights will begin to blink, and the aural alert will sound continuously.

#### Warning messages

A warning is indicated by a continuous aural alert (sounded in the airplane's intercom system), blinking of the red WARNING light, and blinking of the red warning light associated with the affected system.

By pressing the 'acknowledge' button, which is now illuminated green, the aural alert will be terminated, and the WARNING light will be extinguished. The warning light associated with the affected system will change from blinking to solid illumination.

### *Door warning (DOORS)*

The door warning is indicated when one of the two cabin doors is not closed or latched.

### *Starter warning message (START)*

The starter warning message is displayed when the connection between the starter motor and the engine has not been broken. This occurs when the pinion of the starter motor remains engaged.

Furthermore, the START warning light is illuminated continuously as long as the starter is being operated. In this case the WARNING light and the aural alert will not be activated.

The procedure to be followed upon starter warning is given in 3.7.2 - FAILURES IN THE ELECTRICAL SYSTEM.

### *Trim failure warning message (TRIM FAIL)*

The White Wire annunciator panel is prepared for the installation of an autopilot in the DA 40 D. When the autopilot is installed and ready for operation, this warning message indicates a failure of the automatic trim system of the autopilot. For further details, refer to the Supplement to the AFM for the autopilot (if installed).

### Caution messages

A caution is indicated by a momentary aural alert (sounded in the airplane's intercom system), blinking of the amber CAUTION light, and blinking of the amber caution light associated with the affected system.

By pressing the 'acknowledge' button, which is now illuminated green, the CAUTION light will be extinguished. The caution light associated with the affected system will change from blinking to solid illumination.

*Alternator caution message (ALTERNATOR)*

The alternator caution message is displayed on alternator failure. The only remaining source of electrical power is the battery.

The procedure to be followed upon alternator caution is given in 4B.3.4 - ALTERNATOR FAILURE (ALTERNATOR).

*Low voltage caution message (LOW VOLTS)*

The low voltage caution message is displayed when the on-board voltage drops below 12.6 volts. It is terminated when the voltage exceeds 12.9 volts again.

The procedure to be followed upon low voltage caution is given in 4B.3.1 - LOW VOLTAGE CAUTION (LOW VOLTS).

*Engine control unit caution message (ECU A or ECU B)*

This caution message is displayed in case of a malfunction of the related engine control unit (ECU A or ECU B).

■ In case of minor faults, the annunciation can be reset once by pressing the ECU TEST button for more than 2 seconds. However, the annunciation will re-appear upon the next attempt to start the engine.

*Low fuel caution message (LOW FUEL)*

As soon as the amount of usable fuel in the main tank is less than 3 US gal (+2/-1 US gal), this caution message is displayed.

The indication is calibrated for straight and level flight. The caution message may be triggered during turns which are flown with slip, or while taxiing in curves.

*Pitot heating caution message (PITOT)*

The Pitot heating caution message is displayed when the Pitot heating is switched off, or when there is a failure of the Pitot heating system.

Prolonged operation of the Pitot heating on the ground can also cause the Pitot heating caution message to be displayed. In this case it indicates the activation of the thermal switch, which prevents overheating of the Pitot heating system on the ground. This is a normal function of the system. After a cooling period, the heating system will be switched on again automatically.

*Engine parameter caution message (ENGINE)*

This caution message is displayed if a parameter shown on the engine instruments (AED 125 or CED 125) is outside of the green range.

The procedure to be followed is given in 4B.2 - INSTRUMENT INDICATIONS OUTSIDE OF GREEN RANGE.

Status lights*Fuel transfer pump status light (FUEL TRANS)*

This light will be illuminated as long as the electric fuel transfer pump is active.

*Glow plugs status light (GLOW)*

This status light will be illuminated as long as the glow plugs are active.

## **7.11 PITOT-STATIC SYSTEM**

Total pressure is measured at the leading edge of a Pitot probe under the left wing. Static pressure is measured at two orifices at the lower and rear edges of the same probe. To protect against dirt and condensation there are filters in the system, which are accessible from the wing root. The Pitot probe is electrically heated.

With the alternate static valve, the static pressure in the cabin can be used as static pressure source in the event of a failure of the Pitot-static system.

■ If an Autopilot System is installed, additional static sources may be installed.

## **7.12 STALL WARNING SYSTEM**

If airspeed drops below approximately 1.1 times the stalling speed, the stall warning horn, located in the instrument panel, will sound. The horn becomes progressively louder the closer one gets to stalling speed. Suction at an orifice on the left wing leading edge activates the horn via a hose. The orifice for the stall warning in the left wing is marked by a red ring.

## **7.13 AVIONICS**

The radio and navigation equipment is located in the central part of the instrument panel. A push-to-talk (PTT) button for the radio is mounted on the end of each control stick. There are connection facilities for up to 4 headsets between the front seats.



## CHAPTER 8

# AIRPLANE HANDLING, CARE AND MAINTENANCE

	Page
8.1 INTRODUCTION .....	8-2
8.2 AIRPLANE INSPECTION INTERVALS .....	8-2
8.3 AIRPLANE ALTERATIONS OR REPAIRS .....	8-3
8.4 GROUND HANDLING / ROAD TRANSPORT .....	8-3
8.4.1 GROUND HANDLING WITHOUT TOW BAR .....	8-3
8.4.2 GROUND HANDLING WITH TOW BAR .....	8-4
8.4.3 PARKING .....	8-6
8.4.4 MOORING .....	8-8
8.4.5 JACKING .....	8-8
8.4.6 ALIGNMENT .....	8-8
8.4.7 ROAD TRANSPORT .....	8-9
8.5 CLEANING AND CARE .....	8-10
8.5.1 PAINTED SURFACES .....	8-10
8.5.2 CANOPY AND REAR DOOR .....	8-11
8.5.3 PROPELLER .....	8-11
8.5.4 ENGINE .....	8-11
8.5.5 INTERIOR SURFACES .....	8-11
8.6 GROUND DE-ICING .....	8-12

## **8.1 INTRODUCTION**

Chapter 8 contains the manufacturer's recommended procedures for proper ground handling and servicing of the airplane. The Airplane Maintenance Manual (Doc. No. 6.02.01) lists certain inspection and maintenance requirements which must be followed if the airplane is to retain a new plane performance and reliability.

## **8.2 AIRPLANE INSPECTION INTERVALS**

Inspections are scheduled every 50, 100, 200 and 1000 hours. Independent of the flight hours an annual inspection must be performed every year. The respective inspection checklists are prescribed in the Airplane Maintenance Manual, Chapter 05.

For maintenance work on engine and propeller, the currently effective Operator's Manuals, Service Instructions, Service Letters and Service Bulletins of TAE and mt-Propeller must be followed. For airframe inspections, the currently effective checklists/manuals, Service Bulletins and Service Instructions of the manufacturer must be followed.

### **CAUTION**

Unscheduled maintenance checks are required after:

- hard landings
- propeller strike
- engine fire
- lighting strike
- occurrence of other malfunctions and damage

Unscheduled maintenance checks are described in the Airplane Maintenance Manual (Doc. No. 6.02.01; Section 05-50).

### **8.3 AIRPLANE ALTERATIONS OR REPAIRS**

Alterations or repairs of the airplane may be carried out only according to the Airplane Maintenance Manual, Doc. No. 6.02.01, and only by authorized personnel.

### **8.4 GROUND HANDLING / ROAD TRANSPORT**

#### **8.4.1 GROUND HANDLING WITHOUT TOW BAR**

During forward traversing the nose wheel will follow the movement of the airplane. Change in direction is achieved by pulling on the propeller near the spinner. To traverse in the rear direction, the tail section of the airplane should be pushed down until the nose wheel is clear of the ground. This method can also be used to turn the airplane around its main landing gear.

#### **8.4.2 GROUND HANDLING WITH TOW BAR**

For pushing or pulling the airplane on the ground, it is recommended to use the tow bar which is available from the manufacturer. The tow bar is bent apart and engaged in the appropriate holes in the nose wheel fairing as shown on the picture below. The arresting knob must be fully engaged.



**WARNING**

The tow bar must be removed before starting the engine.

**CAUTION**

The tow bar may only be used for moving the airplane on the ground by hand. After moving the airplane, the tow bar must be removed.

**NOTE**

When moving the airplane rearward, the tow bar must be held firmly to prevent abrupt sideward deflection of the nose wheel.

### **8.4.3 PARKING**

For short term parking, the airplane must be positioned into the wind, the parking brake must be engaged and the wing flaps must be in the retracted position. For extended and unattended parking, as well as in unpredictable wind conditions, the airplane must be anchored to the ground or placed in a hangar. Parking in a hangar is recommended.

#### Control surfaces gust lock

The manufacturer offers a control surfaces gust lock which can be used to block the primary controls. It is recommended that the control surfaces gust lock be used when parking outdoors, because otherwise the control surfaces can hit the stops in strong tail wind. This can lead to excessive wear or damage.

### **WARNING**

The control surfaces gust lock must be removed before flight.

The control surfaces gust lock is installed as follows:

1. Move the rudder pedals fully rearward.
2. Engage the control surfaces gust lock with the pedals.
3. Engage the stick, wrap straps around stick once.
4. Attach the locks and tighten the straps.

For removal, reverse the sequence.

### **NOTE**

It is recommended to cover the canopy when the airplane is parked outdoors, in direct sunlight, at outside air temperatures above +25 °C (77 °F), in order to prevent excessive heat generation within the instrument panel which can cause damage to the equipment. Such a canopy cover is available from Diamond Aircraft Industries, P/N: S\_30172.



#### **8.4.4 MOORING**

The tail fin of the airplane has a hole which can be used to tie-down the airplane to the ground. Also on each wing near the wing tip, an eyelet with a metric M8 thread can be installed and used as tie-down points.

#### **8.4.5 JACKING**

The airplane can be jacked at the two jackpoints located on the lower side of the fuselage's LH and RH root ribs as well as at the tail fin.

#### **8.4.6 ALIGNMENT**

For alignment push down on the tail section at the fuselage/vertical tail junction until the nose wheel is clear of the ground. With the nose wheel free, the airplane can be turned around the main landing gear. After turning the airplane into the correct position, release the tail section slowly until the nose wheel is back on the ground.



### **8.4.7 ROAD TRANSPORT**

For transporting the airplane on the road it is recommended that an open trailer be used. All airplane components must be stored on a cushioned surface and secured to avoid any movement during transportation.

#### *1. Fuselage:*

The fuselage should stand on the main and nose landing gear. It must be ensured that the fuselage will not move in any direction. Furthermore, it must be ensured that the propeller has sufficient clearance so that it cannot be damaged due to fuselage movement during transportation.

#### *2. Wings:*

For transportation, both wings must be removed from the fuselage. To avoid any damage, the wings must be stored in an upright position on the leading edge with the root rib area positioned on an upholstered profiled surface with a width of at least 400 mm (1.3 ft). The outside wing area (approximately 3 m (10 ft) from the root rib area) must be placed on an upholstered profiled surface with a minimum width of 300 mm (1 ft).

The wings must be secured to avoid any sliding movement to the rear.

#### *3. Horizontal stabilizer:*

The horizontal stabilizer must be stored flat on the trailer and secured with straps, or in an upright position sitting on the leading edge on a profiled surface. All storing surfaces must be upholstered with felt or cellular rubber.

## **8.5 CLEANING AND CARE**

### **CAUTION**

The airplane must be kept clean. The bright surface prevents the structure from overheating.

### **CAUTION**

Excessive dirt deteriorates the flight performance.

#### **8.5.1 PAINTED SURFACES**

- The entire surface of the airplane is painted with a white weatherproof two component paint. Nevertheless, it is recommended to protect the airplane against moisture and dampness. It is also recommended not to store the airplane outside for long periods of time.

Dirt, insects, etc. can be removed with water alone and if necessary with a mild detergent. An automotive paint cleaner can be used for stubborn spots. For best results, clean the airplane after the day's flying is ended, so that the dirt will not become ingrained.

Oil stains, exhaust stains, etc. on the lower fuselage skin can be removed with a cold detergent. Before starting, ensure that the detergent does not affect the surface finish. Use commercial automotive preservatives without silicone additives to conserve the paint finish.

### **8.5.2 CANOPY AND REAR DOOR**

The canopy and rear door should be cleaned with 'Plexiklar' or any other acrylic glass detergent if available; otherwise use lukewarm water. Final cleaning should be done with a clean piece of chamois-leather or soft cloth. Never rub or polish dry acrylic glass.

### **8.5.3 PROPELLER**

Damage and malfunctions during operation must be inspected by authorized personnel.

#### Surface

The manufacturer uses PU paint or acrylic paint which is resistant to almost any solvent. The blades may be treated with commercial automotive cleaning agents or preservatives. The penetration of moisture into the wooden core must be avoided by all means. Should doubts arise, an appropriately rated inspector must be consulted.

### **8.5.4 ENGINE**

Engine cleaning is part of the scheduled inspections.

### **8.5.5 INTERIOR SURFACES**

The interior should be cleaned using a vacuum cleaner. All loose items (pens, bags etc.) should be removed or properly stored and secured.

All instruments can be cleaned using a soft dry cloth, plastic surfaces should be wiped clean using a damp cloth without any cleaning agents.

**8.6 GROUND DE-ICING**

Approved de-icing fluids are:

Manufacturer	Name
"Kilfrost"	TKS 80
"Aeroshell"	Compound 07
Any source	AL-5 (DTD 406B)

1. Remove any snow from the airplane using a soft brush.
2. Spray de-icing fluid onto ice-covered surfaces using a suitable spray bottle.
3. Use a soft piece of cloth to wipe the airplane dry.

## CHAPTER 9

# SUPPLEMENTS

	Page
9.1 INTRODUCTION .....	9-2
9.2 LIST OF SUPPLEMENTS .....	9-3

## **9.1 INTRODUCTION**

Chapter 9 contains information concerning additional (optional) equipment of the DA 40 D.

Unless otherwise stated, the procedures given in the Supplements must be applied in addition to the procedures given in the main part of the Airplane Flight Manual.

All approved supplements are listed in the List of Supplements in this Chapter.

The Airplane Flight Manual contains exactly those Supplements which correspond to the installed equipment according to the Equipment Inventory of Section 6.5.

## 9.2 LIST OF SUPPLEMENTS

Airplane S/N:		Registration:		Date:	
Sup. No.	Title	Rev. No.	Date	applicable	
				YES	NO
A2	Intercomm System, Model PM 1000 II PS Engineering, Inc.	0	11-Nov-2002	<input type="checkbox"/>	<input type="checkbox"/>
A9	ADF, KR 87 Bendix/King	2	17-Feb-2003	<input type="checkbox"/>	<input type="checkbox"/>
A10	DME, KN 62 A Bendix/King	2	17-Feb-2003	<input type="checkbox"/>	<input type="checkbox"/>
A11	Compass System, KCS 55 A Bendix King	4	15-Mar-2005	<input type="checkbox"/>	<input type="checkbox"/>
A13	Autopilot, KAP 140 Bendix/King	1	26-May-2003	<input type="checkbox"/>	<input type="checkbox"/>
A17	COM / NAV / GPS GNS 430 Garmin	3	22-Jun-2005	<input type="checkbox"/>	<input type="checkbox"/>
A18	Audio Panel, GMA 340 Garmin	2	22-Jun-2005	<input type="checkbox"/>	<input type="checkbox"/>
A19	Transponder, GTX 327 Garmin	0	11-Nov-2002	<input type="checkbox"/>	<input type="checkbox"/>
A20	CDI, GI 106A GARMIN	0	11-Nov-2002	<input type="checkbox"/>	<input type="checkbox"/>

Airplane S/N:

Registration:

Date:

Sup. No.	Title	Rev. No.	Date	applicable	
				YES	NO
A23	GPS Annunciation Unit MD41-1488/1484 MID CONTINENT	1	20-Dec-2002	<input type="checkbox"/>	<input type="checkbox"/>
A24	Stormscope WX 500	2	28-Feb-2003	<input type="checkbox"/>	<input type="checkbox"/>
A25	Audio Panel GMA 340, VFR	2	15-Mar-2005	<input type="checkbox"/>	<input type="checkbox"/>
A26	COM / NAV / GPS GNS 430, VFR GARMIN	1	15-Mar-2005	<input type="checkbox"/>	<input type="checkbox"/>
A28	COM / NAV / GPS GNS 530 (VFR Operation) Garmin	0	20-Mar-2003	<input type="checkbox"/>	<input type="checkbox"/>
A29	Transponder, GTX 330 / GTX 328 Garmin	1	11-Oct-2007	<input type="checkbox"/>	<input type="checkbox"/>
A31	Integrated Avionics System G1000, VFR Operation Garmin	3	01-Jun-2008	<input type="checkbox"/>	<input type="checkbox"/>
A32	Integrated Avionics System G1000, IFR Operation Garmin	3	01-Jun-2008	<input type="checkbox"/>	<input type="checkbox"/>



Airplane S/N:		Registration:		Date:	
Sup. No.	Title	Rev. No.	Date	applicable	
				YES	NO
E3	Attitude Indicator, AIM 1100-14LK(0D) BF Goodrich	1	14-Mar-2003	<input type="checkbox"/>	<input type="checkbox"/>
E4	DIGITAL CHRONOMETER MODEL 803 DAVTRON	0	11-Nov-2002	<input type="checkbox"/>	<input type="checkbox"/>
E5	Attitude Indicator, LUN 1241 MIKROTECHNA	0	11-Nov-2002	<input type="checkbox"/>	<input type="checkbox"/>
E6	Operation with Baggage Extension and Baggage Tray	0	09-Jan-2004	<input type="checkbox"/>	<input type="checkbox"/>
E7	Winter Baffle Fresh Air Inlet	1	27-Apr-2005	<input type="checkbox"/>	<input type="checkbox"/>
S1	Emergency Locator Transmitter, Model E-01 ACK	0	11-Nov-2002	<input type="checkbox"/>	<input type="checkbox"/>
S2	Emergency Locator Transmitter, JE2-NG JOLLIET ELECTRONIQUE	0	11-Nov-2002	<input type="checkbox"/>	<input type="checkbox"/>

Supplements



DA 40 D AFM

Airplane S/N:

Registration:

Date:

Sup. No.	Title	Rev. No.	Date	applicable	
				YES	NO
S3	Emergency Locator Transmitter ELT, ARTEX C406-1	0	12-May-2003	<input type="checkbox"/>	<input type="checkbox"/>
S4	ELT Artex ME 406	1	10-Apr-2007	<input type="checkbox"/>	<input type="checkbox"/>